



Adem DEĞERLİ  
Genel Müdür  
General Manager

SEVGİLİ DOSTLARIMIZ ;

DEĞERLİ MAKİNA bilindiği üzere 1987 yılında KONYA'da başladığı HASSAS TUTUCU TAKIM imalatına bugüne kadar yapmış olduğu teknoloji yatırımları ile beraber, kalitesinden taviz vermeden sürekli ürün çeşidini artırma yolunda ilerlemiştir. Üretiminin bir kısmını yurt dışına ihraç ederek de ülke ekonomisine ciddi girdiler sağlamıştır.

Firmamız siz kıymetli dostlarımıza daha iyi hizmet verebilmek amacı ile makina parkını ve personel sayısını her geçen gün artırmaya devam etmektedir.

Şirketimiz ürünlerinin kalitesini ve hizmet anlayışını siz değerli dostlarımız ile paylaşmak amacı ile birçok fuar'a katılarak ismine yakışır bir tanıtım yapmış ve halen de yapmaya devam etmektedir.

Ayrıca ürünlerimizin ve hizmetimizin kalitesini 2006 yılında büyük bir özveri ile çalışarak almaya hak kazandığı EN ISO 9001 kalite belgesi ile kanıtlamıştır.

Firmamız bundan böyle siz kıymetli dostlarımızında desteği ile daha da ileriye gidecek, aynı zamanda kalitesinden ve hizmetinden kesinlikle ödün vermeyecektir.

Dear All,

As it known, DEGERLİ MAKİNA began in 1987 in Konya PRECISION HOLDER TOOL manufacturing together with technology investments made by this time, along with continuous product range without compromising the quality of the way of improving progressed. By exporting a portion of is production abroad has contributed substantially to the national economy.

In order to better serve to our precious customers, our company always continues to increase its machinery and the number of stuff.

Our company has participated to various exhibitions and stil continues to do well for sharing our sense of our quality and services with our dear friends,

In addition, the quality of our products and our services is awarded in 2006 by working with a great sacrifice has been certified by ISO 9001 quality certificate.

Our company is now going even further with your precious support of but also will not compromise on quality and service, definitely.

## KALİTE POLİTİKAMIZ

Müşterilerimize dünya standartlarında, yasal ve teknik mevzuata uygun kaliteli ürünler sunmak.

Çalışanlarımızı ve tedarikçilerimizi büyüme ve gelişmemizde ortak bilip, teknolojiye yeni yenilikleri firmamıza uyarlayarak sektörde lider firma olmak.

Personelimizin bilgi ve becerilerini artırma konusunda eğitime önem vermek.

Çevreye karşı saygılı olmak.

Sürekli iyileştirme anlayışı içinde, TEKNOLOJİ VE GÜVENİN BİRLEŞTİĞİ YER olan DEĞERLİ MAKİNA'YI her geçen gün yeni başarılarla taşımaktır.

## QUALITY POLICY

Offering high quality products in worldwide standards suitable for legal and technical regulations.

Aiming to be the leader of the sector by applying technical renovations in our company and considering our staff and suppliers as partners in growing and improvement process.

Considering on the job training important to improve skills and cognition of our staff.

Being respectful to the environment.

In view of constantly improving, taking DEĞERLİ MAKİNA, where technology and confidence combined, to sustain new success in each day.





Ürünlerimizin kalitesinden taviz vermemek amacı ile imalat esnasında ve imalat sonrasında ürünler sürekli kontrol edilerek hataya sebebiyet vermemekteyiz.

Bu kontrollerden en can alıcı olanları ise başta ISIL İŞLEM olmak üzere sonrasında yapılan SERTLİK ÖLÇME analizi, imalat esnasında yapılan YÜZEY PÜRÜZLÜLÜK hassasiyet ölçümü ve son olarak BALANS alma işlemidir. Bu işlemlerimizin tamamı raporlar halinde arşivlenerek muhafaza edilmektedir.

Ürünlerimizi müşterilerimiz tarafından daha anlaşılabilir olması için LAZER Markalama ile ürün bilgilerini ürünün üzerine yazmaktayız. Böylelikle müşterilerimiz bir daha ürün ihtiyacı olduğunda tercihini buna göre yapması kolay olacaktır.

Sonuç olarak amacımız daha hassas ve daha kaliteli ürün imalatı yaparak müşterilerimizin memnuniyetini en üst seviyede tutmaktır.

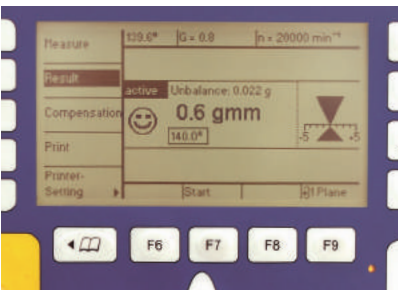

In order to not to concession from the quality, the goods controlled during pre and post production process, so that we do not cause any error.

The most vital important controls are foremost **THERMAL PROCESS**, then **HARDNESS MEASUREMENT** analysis, sensitivity measurement of **SURFACE ROUGHNESS** during production and **BALANCING** process. All of these procedures are being documented and kept.

The product information is written on the product by **LASER MARKING** for the customers to be well informed about the products. Thus, our customers will be able to choose the product easily next time.

Consequently, our purpose is to manufacture more sensitive and quality goods and keep customer satisfaction at the highest level.

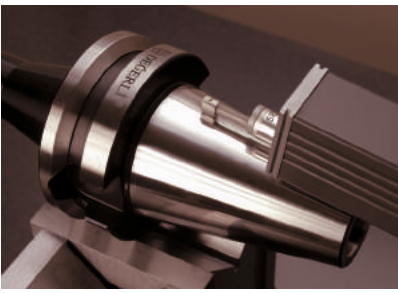
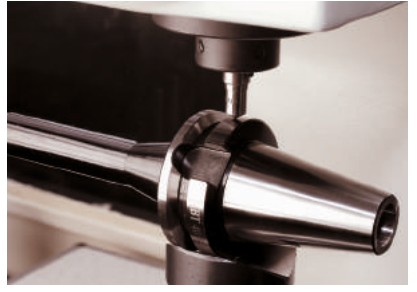



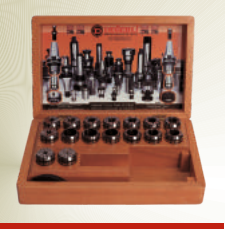

## PENSLELER / Collets

DIN 6499 ER  
ER PENS / ColletsSAYFA / PAGE  
A - 01 / 02 / 03 / 04 / 05DIN 6388  
PENS / ColletsSAYFA / PAGE  
A - 06 / 07 / 08 /  
09 / 10 / 11RULMANLI TUTUCU PENSİ  
Bearing holder colletSAYFA / PAGE  
A - 12 / 13DIN 6343  
PENS  
ColletSAYFA / PAGE  
A - 14RAY FENG PENSİ  
Ray Feng colletSAYFA / PAGE  
A - 15DIN 6388  
PENS TAKIMI  
Collet setSAYFA / PAGE  
A - 16DIN 6499 ER  
ER PENS TAKIMI  
Collet setSAYFA / PAGE  
A - 17DIN 6388  
TAKIM İÇERİĞİ  
Set TypeSAYFA / PAGE  
A - 18 / 19DIN 6499 ER  
TAKIM İÇERİĞİ  
Set TypeSAYFA / PAGE  
A - 20 / 21

## DIN 2080 ISO TUTUCULAR / Toolholders

DIN 2080  
ŞAFT ÖLÇÜLERİ  
Toolholders NormSAYFA / PAGE  
B - 01DIN 6388  
PENS BAŞLIĞI  
Collet chucksSAYFA / PAGE  
B - 02DIN 6499 ER  
PENS BAŞLIĞI  
Collet chucksSAYFA / PAGE  
B - 03DIN 6358  
KOMBİNE TUTUCU  
Combi shell mill holderSAYFA / PAGE  
B - 04DIN 6357  
ALIN KAMALI TUTUCU  
Shell mill holderSAYFA / PAGE  
B - 05DIN 6359 / DIN 1835-B  
WELDON TUTUCU  
End mill holderSAYFA / PAGE  
B - 06 / 07





DIN 6383  
KAMALI MORS  
ADAPTÖRÜ  
Morse taper adaptor tang

SAYFA / PAGE  
B - 08



DIN 6364  
CEKTIRMELİ MORS  
ADAPTÖRÜ  
Morse taper adaptor  
drawbar

SAYFA / PAGE  
B - 09



DIN 238  
MANDREN BAŞLIĞI  
Drill chuck adaptor

SAYFA / PAGE  
B - 10



DIN 2080  
ISO & ISO ADAPTÖR

SAYFA / PAGE  
B - 11



DIN 6388  
PENS TAKIMLARI  
Collet set

SAYFA / PAGE  
B - 12



DIN 6499 ER  
PENS TAKIMLARI  
Collet set

SAYFA / PAGE  
B - 13

## JIS B 6339 ( MAS 403 BT ) TUTUCULAR / Toolholders



JIS B 6339 ( MAS 403 BT )  
ŞAFT ÖLÇÜLERİ  
Toolholders Norm

SAYFA / PAGE  
C - 01



DIN 6388  
PENS BAŞLIĞI  
Collet chucks

SAYFA / PAGE  
C - 02



DIN 6499 ER  
PENS BAŞLIĞI  
Collet chucks

SAYFA / PAGE  
C - 03



A - 100

DIN 6499 ER  
PENS BAŞLIĞI  
Collet chucks

SAYFA / PAGE  
C - 04

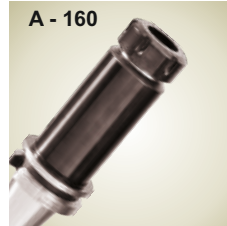

A - 160

DIN 6499 ER  
PENS BAŞLIĞI  
Collet chucks

SAYFA / PAGE  
C - 05



DIN 6499 ER  
HASSAS AYARLANABİLİR  
PENS BAŞLIĞI  
Adjustable tool holder

SAYFA / PAGE  
C - 06



RULMANLI PENS BAŞLIĞI  
Bearing collet chucks

SAYFA / PAGE  
C - 07



DIN 6358  
KOMBİNE TUTUCU  
Combi shell mill holder

SAYFA / PAGE  
C - 08



A - 100

DIN 6358  
KOMBİNE TUTUCU  
Combi shell mill holder

SAYFA / PAGE  
C - 09



A - 160

DIN 6358  
KOMBİNE TUTUCU  
Combi shell mill holder

SAYFA / PAGE  
C - 10



DIN 6357  
ALIN KAMALI TUTUCU  
Shell mill holder

SAYFA / PAGE  
C - 11

















A - 250

DIN 6357  
ALIN KAMALI TUTUCU  
Shell mill holder

SAYFA / PAGE  
C - 12

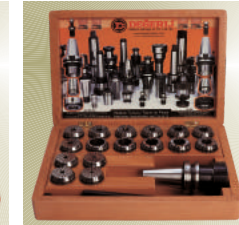
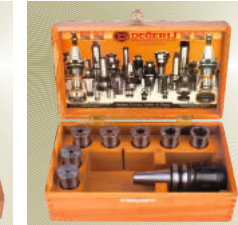

|   |  |  |   |  |   |
|---|--|--|---|--|---|
| <p><b>BT 30</b></p>  <p>DIN 6359 / DIN 1835-B<br/>WELDON TUTUCU<br/>End mill holder</p> <p><b>SAYFA / PAGE</b><br/>C - 13</p>                       | <p><b>BT 40</b></p>  <p>DIN 6359 / DIN 1835-B<br/>WELDON TUTUCU<br/>End mill holder</p> <p><b>SAYFA / PAGE</b><br/>C - 14</p>                 | <p><b>BT 40 / A - 100</b></p>  <p>DIN 6359 / DIN 1835-B<br/>WELDON TUTUCU<br/>End mill holder</p> <p><b>SAYFA / PAGE</b><br/>C - 15</p> | <p><b>BT 40 / A - 160</b></p>  <p>DIN 6359 / DIN 1835-B<br/>WELDON TUTUCU<br/>End mill holder</p> <p><b>SAYFA / PAGE</b><br/>C - 16</p> | <p><b>BT 50</b></p>  <p>DIN 6359 / DIN 1835-B<br/>WELDON TUTUCU<br/>End mill holder</p> <p><b>SAYFA / PAGE</b><br/>C - 17</p>                                 | <p><b>BT 50 / A - 160</b></p>  <p>DIN 6359 / DIN 1835-B<br/>WELDON TUTUCU<br/>End mill holder</p> <p><b>SAYFA / PAGE</b><br/>C - 18</p>            |
|  <p>DIN 6383<br/>KAMALI MORS<br/>ADAPTÖRÜ<br/>Morse taper adaptor<br/>tang</p> <p><b>SAYFA / PAGE</b><br/>C - 19</p>                               |  <p>DIN 6364<br/>ÇEKTİRMELİ MORS<br/>ADAPTÖRÜ<br/>Morse taper adaptor<br/>drawbar</p> <p><b>SAYFA / PAGE</b><br/>C - 20</p>                  |  <p>DIN 238<br/>MANDREN BAŞLIĞI<br/>Drill chuck adaptor</p> <p><b>SAYFA / PAGE</b><br/>C - 21</p>                                      |  <p>NC TİP<br/>MANDRENLİ TUTUCU<br/>NC Drill Chucks</p> <p><b>SAYFA / PAGE</b><br/>C - 22</p>  |  <p>KLAVUZ ÇEKME BAŞLIĞI<br/>GİRİŞ ÇIKIŞ KOMPANZİYELİ<br/>Quick change tapping chucks<br/>with length compensation</p> <p><b>SAYFA / PAGE</b><br/>C - 23</p> | <p><b>BT 40</b></p>  <p>VİDALI FREZE TAKIM<br/>TUTUCULARI<br/>Set holders for screw<br/>milling cutters</p> <p><b>SAYFA / PAGE</b><br/>C - 24</p> |
| <p><b>BT 50</b></p>  <p>VİDALI FREZE TAKIM<br/>TUTUCULARI<br/>Set holders for screw<br/>milling cutters</p> <p><b>SAYFA / PAGE</b><br/>C - 25</p> |  <p>ÖZEL TAKIM YAPMAK<br/>İÇİN YUMUŞAK BARA<br/>Boring bar blanks for<br/>producing special tools</p> <p><b>SAYFA / PAGE</b><br/>C - 26</p> |  <p>DIN 6388<br/>PENS TAKIMI<br/>Collet set</p> <p><b>SAYFA / PAGE</b><br/>C - 27</p>   |  <p>DIN 6499 ER<br/>PENS TAKIMI<br/>Collet set</p> <p><b>SAYFA / PAGE</b><br/>C - 28</p>  |  <p>RULMANLI PENS TAKIMI<br/>Collet set</p> <p><b>SAYFA / PAGE</b><br/>C - 29</p>   |   |



## SİLİNDİRİK ŞAFTLI TUTUCULAR



DIN 6499 ER  
SİL.ŞAFT PENS TUTUCU  
Collet chuck with  
straight shank DIN 6499

SAYFA / PAGE  
D - 01 / 02 / 03 / 04



SİLİNDİRİK ŞAFTLI  
KATER REDÜKSİYONU  
Cylindrical toolholder cat  
reduction

SAYFA / PAGE  
D - 05 / 06 / 07 / 08 / 09



SİLİNDİRİK ŞAFTLI  
MORS KONİK ADAPTÖR  
Cylindrical toolholder  
morse adaptor

SAYFA / PAGE  
D - 10



SİLİND.ŞAFTLI GİRİŞ-ÇIKIŞ  
KOMPANZİYELİ PENS TUTUCU  
KLAVUZ ÇEKME BAŞLIĞI  
Cylindrical shank with  
compensation and collet chuck  
tapping length

SAYFA / PAGE  
D - 11



SİLİND.ŞAFTLI GİRİŞ-ÇIKIŞ  
KOMPANZİYELİ KLAVUZ  
ÇEKME BAŞLIĞI  
Quick-change tapping chucks  
with length compensation

SAYFA / PAGE  
D - 12



DIN 6499 ER  
PENS TAKIMI  
Collet set

SAYFA / PAGE  
D - 13

## DIN 69871 AD SK TUTUCULAR / Toolholders



DIN 63871 AD SK  
ŞAFT ÖLÇÜLERİ  
Toolholders Norm

SAYFA / PAGE  
E - 01



DIN 6388  
PENS BAŞLIĞI  
Collet chucks

SAYFA / PAGE  
E - 02



DIN 6499 ER  
PENS BAŞLIĞI  
Collet chucks

SAYFA / PAGE  
E - 03



A - 100

DIN 6499 ER  
PENS BAŞLIĞI  
Collet chucks

SAYFA / PAGE  
E - 04



A - 160

DIN 6499 ER  
PENS BAŞLIĞI  
Collet chucks

SAYFA / PAGE  
E - 05



DIN 6499 ER  
HASSAS AYARLANABİLİR  
PENS BAŞLIĞI  
Adjustable tool holder

SAYFA / PAGE  
E - 06



RULMANLI PENS BAŞLIĞI  
Bearing collet chucks

SAYFA / PAGE  
E - 07



DIN 6358  
KOMBİNE TUTUCU  
Combi shell mill holder

SAYFA / PAGE  
E - 08



A - 100

DIN 6358  
KOMBİNE TUTUCU  
Combi shell mill holder

SAYFA / PAGE  
E - 09



A - 160

DIN 6358  
KOMBİNE TUTUCU  
Combi shell mill holder

SAYFA / PAGE  
E - 10



DIN 6357  
ALIN KAMALI TUTUCU  
Shell mill holder

SAYFA / PAGE  
E - 11













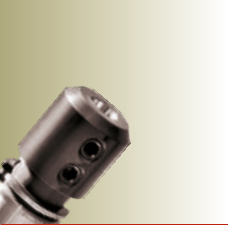
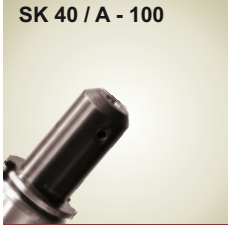
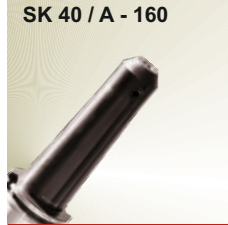

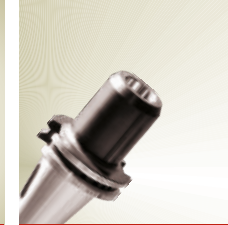
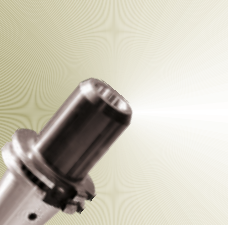
SK 30

DIN 6359 / DIN 1835 - B  
WELDON TUTUCU  
End mill holder

SAYFA / PAGE  
E - 12





|  |   |   |   |   |  |
|--|---|---|---|---|--|
|            | <b>SK 40 / A - 100</b><br> | <b>SK 40 / A - 160</b><br> | <b>SK 50</b><br>          | <b>SK 50 / A - 160</b><br> |   |
| DIN 6359 / DIN 1835-B<br>WELDON TUTUCU<br>End mill holder                                  | DIN 6359 / DIN 1835-B<br>WELDON TUTUCU<br>End mill holder   | DIN 6359 / DIN 1835-B<br>WELDON TUTUCU<br>End mill holder   | DIN 6359 / DIN 1835-B<br>WELDON TUTUCU<br>End mill holder   | DIN 6359 / DIN 1835-B<br>WELDON TUTUCU<br>End mill holder   | DIN 6383<br>KAMALI MORS<br>ADAPTÖRÜ<br>Morse taper adaptor tang                      |
| <b>SAYFA / PAGE</b><br>E - 13  | <b>SAYFA / PAGE</b><br>E - 14   | <b>SAYFA / PAGE</b><br>E - 15   | <b>SAYFA / PAGE</b><br>E - 16   | <b>SAYFA / PAGE</b><br>E - 17   | <b>SAYFA / PAGE</b><br>E - 18  |
|           |                           |                           |                          |                           |  |
| DIN 6364<br>ÇEKTİRMELİ MORS<br>ADAPTÖRÜ<br>Morse taper adaptor<br>drawbar                  | DIN 238<br>MANDREN BAŞLIĞI<br>Drill chuck adaptor   | NC TİP<br>MANDRENLİ TUTUCU<br>NC-Drill Chucks   | KLAVUZ ÇEKME BAŞLIĞI<br>GİRİŞ ÇIKIŞ KOMPANZİYELİ<br>Quick change tapping chucks<br>with length compensation | VİDALI FREZE TAKIM<br>TUTUCULARI<br>Set holders for screw<br>milling cutters                                  | VİDALI FREZE TAKIM<br>TUTUCULARI<br>Set holders for screw<br>milling cutters         |
| <b>SAYFA / PAGE</b><br>E - 19  | <b>SAYFA / PAGE</b><br>E - 20   | <b>SAYFA / PAGE</b><br>E - 21   | <b>SAYFA / PAGE</b><br>E - 22   | <b>SAYFA / PAGE</b><br>E - 23   | <b>SAYFA / PAGE</b><br>E - 24  |
|          |                          |                          |                         |   |  |
| ÖZEL TAKIM YAPMAK<br>İÇİN YUMUŞAK BARA<br>Boring bar blanks for<br>producing special tools | DIN 6388<br>PENS TAKIMI<br>Collet set   | DIN 6499 ER<br>PENS TAKIMI<br>Collet set  | RULMANLI PENS TAKIMI<br>Collet set  |   |  |
| <b>SAYFA / PAGE</b><br>E - 25  | <b>SAYFA / PAGE</b><br>E - 26   | <b>SAYFA / PAGE</b><br>E - 27   | <b>SAYFA / PAGE</b><br>E - 28   |   |  |



## DIN 228 - 1 / FORM A



DIN 228 - 1 / FORM A  
ŞAFT ÖLÇÜLERİ  
Toolholders Norm

SAYFA / PAGE  
F - 01



DIN 6388  
PENS BAŞLIĞI  
Collet chucks

SAYFA / PAGE  
F - 02



DIN 6358  
KOMBİNE TUTUCU  
Combi shell mill holder

SAYFA / PAGE  
F - 03

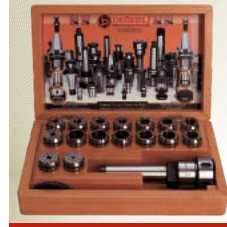

DIN 6388  
PENS TAKIMI  
Collet set

SAYFA / PAGE  
F - 04

## DIN 228 - 1 / DIN 1806 FORM B



DIN 228 - 1 / FORM B  
ŞAFT ÖLÇÜLERİ  
Toolholders Norm

SAYFA / PAGE  
F - 05



DIN 6388  
PENS BAŞLIĞI  
Collet chucks

SAYFA / PAGE  
F - 06



DIN 6358  
KOMBİNE TUTUCU  
Combi shell mill holder

SAYFA / PAGE  
F - 07

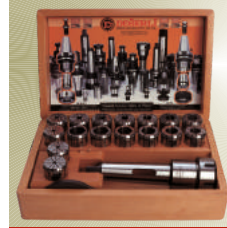

DIN 6388  
PENS TAKIMI  
Collet set

SAYFA / PAGE  
F - 08

## DİĞER ÜRÜNLER / Other products



DIN 1810 A  
AY ANAHTARI  
Wrench

SAYFA / PAGE  
G - 01



ER TİPİ ANAHTAR  
Wrench ER

SAYFA / PAGE  
G - 02



BİLYALI PENS AYNASI  
Quick action Collet chucks

SAYFA / PAGE  
G - 03



DIN 55021  
HİDROLİK PENS AYNASI  
Power chucks

SAYFA / PAGE  
G - 04



EMNİYETLİ TİP  
KLAVUZ TUTUCU  
Tapping collets with clutch

SAYFA / PAGE  
G - 05 / 06 / 07

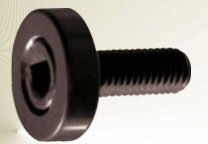

TARAMA KİLİT VIDASI  
Lock screw

SAYFA / PAGE  
G - 08



DIN 6366  
TAŞIYICI TIRNAKLI PUL  
Driving ring

SAYFA / PAGE  
G - 09



MONTAJ APARATI  
ALÜMİNYUM  
Tightening fixtures  
Aluminium

SAYFA / PAGE  
G - 10



ÇELİK MONTAJ APARATI  
Universal assembly  
block steel

SAYFA / PAGE  
G - 11



DIN 6388  
PENS KAPAĞI  
Clamping nuts  
ball-bearing version

SAYFA / PAGE  
G - 12



DIN 6499 ER  
PENS KAPAĞI  
Clamping nuts

SAYFA / PAGE  
G - 13



ISO 7388 UND CAT  
ÇEKTİRME CİVATALARI  
Pull studs

SAYFA / PAGE  
G - 14



DIN 69872 A+B  
ÇEKTİRME CİVATALARI  
Pull studs

SAYFA / PAGE  
G - 15



JIS B 6339 (MAS 403 BT)  
ÇEKTİRME CİVATALARI  
Pull studs

SAYFA / PAGE  
G - 16



JIS B 6339 (MAS 403 BT)  
İÇTEN SOĞUTMALI  
ÇEKTİRME CİVATALARI  
Pull studs

SAYFA / PAGE  
G - 17



DIN 2080  
ÇEKTİRME CİVATALARI  
Pull studs

SAYFA / PAGE  
G - 18



HİDROLİK TEZGAH  
MENGENESİ  
Hydraulic machine vices

SAYFA / PAGE  
G - 19



DIN 1835 B  
WELDON CİVATASI  
Clamping screw weldon

SAYFA / PAGE  
G - 20



TAKIM ARABASI  
Set car

SAYFA / PAGE  
G - 21



DIN 238  
SUPRA MANDREN  
Drill chuck





---

**pensler  
collets**

---



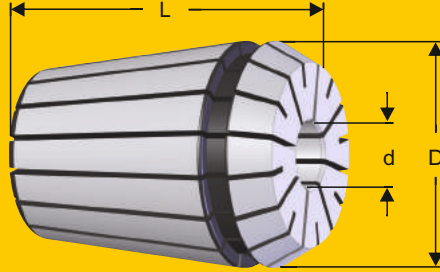

Sayfa : G-02  
Page : G-02



Sayfa : G-02  
Page : G-02



Sayfa : G-13  
Page : G-13



Sayfa : G-13  
Page : G-13



Sayfa : G-13  
Page : G-13



Sayfa : A-17  
Page : A-17

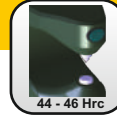

44 - 46 Hrc



VN5

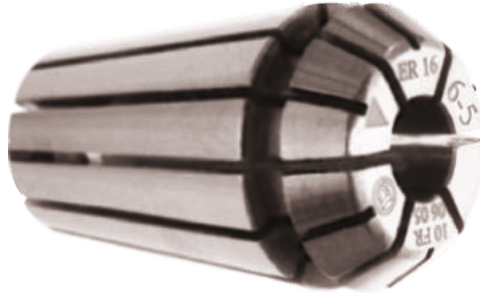

| SİPARİŞ KODU<br>Order Number | ÜRÜN ADI<br>Product Name | KAPASİTE<br>Capacity ( d ) | D  | L    |
|------------------------------|--------------------------|----------------------------|----|------|
| 100426.02                    | ER 16 / 426              | 2 mm                       | 17 | 27,5 |
| 100426.03                    | ER 16 / 426              | 3 - 2 mm                   | 17 | 27,5 |
| 100426.04                    | ER 16 / 426              | 4 - 3 mm                   | 17 | 27,5 |
| 100426.05                    | ER 16 / 426              | 5 - 4 mm                   | 17 | 27,5 |
| 100426.06                    | ER 16 / 426              | 6 - 5 mm                   | 17 | 27,5 |
| 100426.07                    | ER 16 / 426              | 7 - 6 mm                   | 17 | 27,5 |
| 100426.08                    | ER 16 / 426              | 8 - 7 mm                   | 17 | 27,5 |
| 100426.09                    | ER 16 / 426              | 9 - 8 mm                   | 17 | 27,5 |
| 100426.10                    | ER 16 / 426              | 10 - 9 mm                  | 17 | 27,5 |

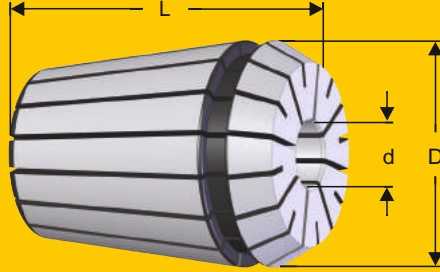

Sayfa : G-02  
Page : G-02



Sayfa : G-02  
Page : G-02



Sayfa : G-13  
Page : G-13



Sayfa : G-13  
Page : G-13



Sayfa : G-13  
Page : G-13



Sayfa : A-17  
Page : A-17

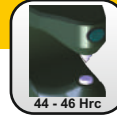

44 - 46 Hrc



VN5



| SİPARİŞ KODU<br>Order Number | ÜRÜN ADI<br>Product Name | KAPASİTE<br>Capacity ( d ) | D  | L    |
|------------------------------|--------------------------|----------------------------|----|------|
| 100428.02                    | ER 20 / 428              | 2 mm                       | 21 | 31,5 |
| 100428.03                    | ER 20 / 428              | 3 - 2 mm                   | 21 | 31,5 |
| 100428.04                    | ER 20 / 428              | 4 - 3 mm                   | 21 | 31,5 |
| 100428.05                    | ER 20 / 428              | 5 - 4 mm                   | 21 | 31,5 |
| 100428.06                    | ER 20 / 428              | 6 - 5 mm                   | 21 | 31,5 |
| 100428.07                    | ER 20 / 428              | 7 - 6 mm                   | 21 | 31,5 |
| 100428.08                    | ER 20 / 428              | 8 - 7 mm                   | 21 | 31,5 |
| 100428.09                    | ER 20 / 428              | 9 - 8 mm                   | 21 | 31,5 |
| 100428.10                    | ER 20 / 428              | 10 - 9 mm                  | 21 | 31,5 |
| 100428.11                    | ER 20 / 428              | 11 - 10 mm                 | 21 | 31,5 |
| 100428.12                    | ER 20 / 428              | 12 - 11 mm                 | 21 | 31,5 |



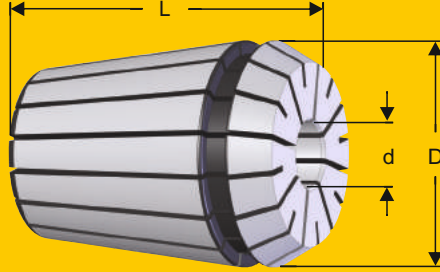

Sayfa : G-02  
Page : G-02



Sayfa : G-13  
Page : G-13



Sayfa : A-17  
Page : A-17



Sayfa : B-13  
Page : B-13



Sayfa : C-28  
Page : C-28



Sayfa : D-13  
Page : D-13



Sayfa : E-27  
Page : E-27

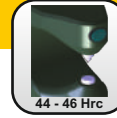

44 - 46 Hrc



VN5

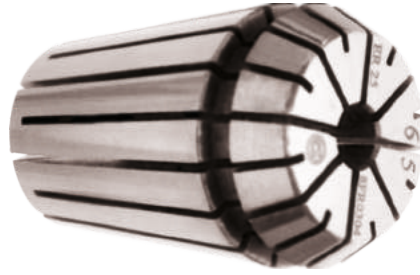

| SİPARİŞ KODU<br>Order Number | ÜRÜN ADI<br>Product Name | KAPASİTE<br>Capacity ( d ) | D  | L  |
|------------------------------|--------------------------|----------------------------|----|----|
| 100430.02                    | ER 25 / 430              | 2 mm                       | 26 | 34 |
| 100430.03                    | ER 25 / 430              | 3 - 2 mm                   | 26 | 34 |
| 100430.04                    | ER 25 / 430              | 4 - 3 mm                   | 26 | 34 |
| 100430.05                    | ER 25 / 430              | 5 - 4 mm                   | 26 | 34 |
| 100430.06                    | ER 25 / 430              | 6 - 5 mm                   | 26 | 34 |
| 100430.07                    | ER 25 / 430              | 7 - 6 mm                   | 26 | 34 |
| 100430.08                    | ER 25 / 430              | 8 - 7 mm                   | 26 | 34 |
| 100430.09                    | ER 25 / 430              | 9 - 8 mm                   | 26 | 34 |
| 100430.10                    | ER 25 / 430              | 10 - 9 mm                  | 26 | 34 |
| 100430.11                    | ER 25 / 430              | 11 - 10 mm                 | 26 | 34 |
| 100430.12                    | ER 25 / 430              | 12 - 11 mm                 | 26 | 34 |
| 100430.13                    | ER 25 / 430              | 13 - 12 mm                 | 26 | 34 |
| 100430.14                    | ER 25 / 430              | 14 - 13 mm                 | 26 | 34 |
| 100430.15                    | ER 25 / 430              | 15 - 14 mm                 | 26 | 34 |
| 100430.16                    | ER 25 / 430              | 16 - 15 mm                 | 26 | 34 |

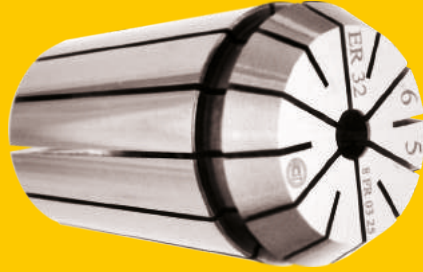
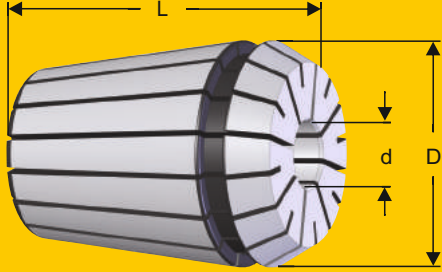

Sayfa : G-02  
Page : G-02



Sayfa : G-13  
Page : G-13



Sayfa : A-17  
Page : A-17



Sayfa : B-13  
Page : B-13



Sayfa : C-28  
Page : C-28



Sayfa : D-13  
Page : D-13



Sayfa : E-27  
Page : E-27

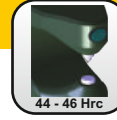

44 - 46 Hrc



VN5

| SİPARİŞ KODU<br>Order Number | ÜRÜN ADI<br>Product Name | KAPASİTE<br>Capacity ( d ) | D  | L  |
|------------------------------|--------------------------|----------------------------|----|----|
| 100470.02                    | ER 32 / 470              | 2 mm                       | 33 | 40 |
| 100470.03                    | ER 32 / 470              | 3 - 2 mm                   | 33 | 40 |
| 100470.04                    | ER 32 / 470              | 4 - 3 mm                   | 33 | 40 |
| 100470.05                    | ER 32 / 470              | 5 - 4 mm                   | 33 | 40 |
| 100470.06                    | ER 32 / 470              | 6 - 5 mm                   | 33 | 40 |
| 100470.07                    | ER 32 / 470              | 7 - 6 mm                   | 33 | 40 |
| 100470.08                    | ER 32 / 470              | 8 - 7 mm                   | 33 | 40 |
| 100470.09                    | ER 32 / 470              | 9 - 8 mm                   | 33 | 40 |
| 100470.10                    | ER 32 / 470              | 10 - 9 mm                  | 33 | 40 |
| 100470.11                    | ER 32 / 470              | 11 - 10 mm                 | 33 | 40 |
| 100470.12                    | ER 32 / 470              | 12 - 11 mm                 | 33 | 40 |
| 100470.13                    | ER 32 / 470              | 13 - 12 mm                 | 33 | 40 |
| 100470.14                    | ER 32 / 470              | 14 - 13 mm                 | 33 | 40 |
| 100470.15                    | ER 32 / 470              | 15 - 14 mm                 | 33 | 40 |
| 100470.16                    | ER 32 / 470              | 16 - 15 mm                 | 33 | 40 |
| 100470.17                    | ER 32 / 470              | 17 - 16 mm                 | 33 | 40 |
| 100470.18                    | ER 32 / 470              | 18 - 17 mm                 | 33 | 40 |
| 100470.19                    | ER 32 / 470              | 19 - 18 mm                 | 33 | 40 |
| 100470.20                    | ER 32 / 470              | 20 - 19 mm                 | 33 | 40 |

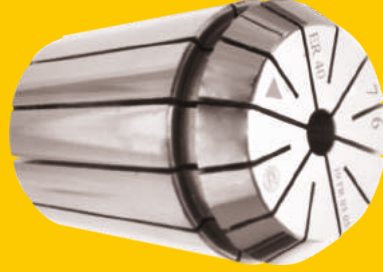
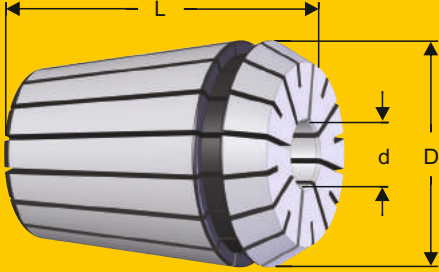

Sayfa : G-02  
Page : G-02



Sayfa : G-13  
Page : G-13



Sayfa : A-17  
Page : A-17



Sayfa : B-13  
Page : B-13



Sayfa : C-28  
Page : C-28



Sayfa : D-13  
Page : D-13



Sayfa : E-27  
Page : E-27

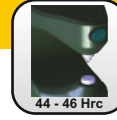

44 - 46 Hrc



VNS

| SİPARİŞ KODU<br>Order Number | ÜRÜN ADI<br>Product Name | KAPASİTE<br>Capacity ( d ) | D  | L  |
|------------------------------|--------------------------|----------------------------|----|----|
| 100472.04                    | ER 40 / 472              | 4 - 3 mm                   | 41 | 46 |
| 100472.05                    | ER 40 / 472              | 5 - 4 mm                   | 41 | 46 |
| 100472.06                    | ER 40 / 472              | 6 - 5 mm                   | 41 | 46 |
| 100472.07                    | ER 40 / 472              | 7 - 6 mm                   | 41 | 46 |
| 100472.08                    | ER 40 / 472              | 8 - 7 mm                   | 41 | 46 |
| 100472.09                    | ER 40 / 472              | 9 - 8 mm                   | 41 | 46 |
| 100472.10                    | ER 40 / 472              | 10 - 9 mm                  | 41 | 46 |
| 100472.11                    | ER 40 / 472              | 11 - 10 mm                 | 41 | 46 |
| 100472.12                    | ER 40 / 472              | 12 - 11 mm                 | 41 | 46 |
| 100472.14                    | ER 40 / 472              | 14 - 13 mm                 | 41 | 46 |
| 100472.16                    | ER 40 / 472              | 16 - 15 mm                 | 41 | 46 |
| 100472.18                    | ER 40 / 472              | 18 - 17 mm                 | 41 | 46 |
| 100472.20                    | ER 40 / 472              | 20 - 19 mm                 | 41 | 46 |
| 100472.22                    | ER 40 / 472              | 22 - 21 mm                 | 41 | 46 |
| 100472.24                    | ER 40 / 472              | 24 - 23 mm                 | 41 | 46 |
| 100472.26                    | ER 40 / 472              | 26 - 25 mm                 | 41 | 46 |

HARİCİ ÖLÇÜLER : 2 mm, 3-2 mm, 13-12 mm, 15-14 mm, 17-16 mm, 19-18 mm, 21-20 mm, 23-22 mm, 25-24 mm  
( External Dimension )



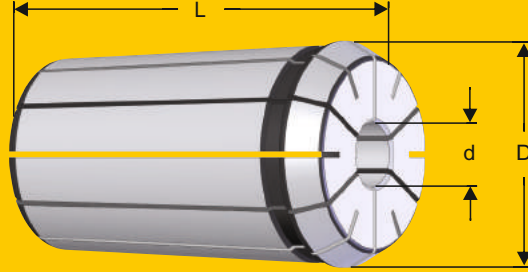

Sayfa : G-12  
Page : G-12



Sayfa : A-16  
Page : A-16

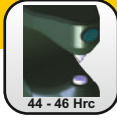

44 - 46 Hrc



VN5

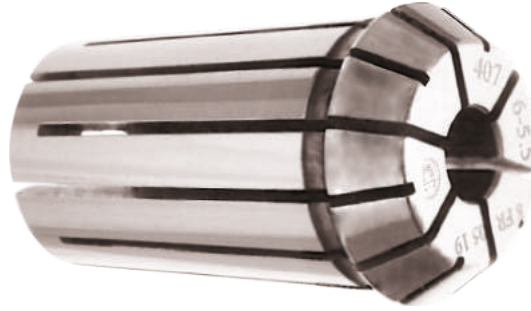

| SİPARİŞ KODU<br>Order Number | ÜRÜN ADI<br>Product Name | KAPASİTE<br>Capacity ( d ) | D     | L  |
|------------------------------|--------------------------|----------------------------|-------|----|
| 100407.03                    | 407                      | 3 - 2,5 mm                 | 19,80 | 34 |
| 100407.04                    | 407                      | 4 - 3,5 mm                 | 19,80 | 34 |
| 100407.05                    | 407                      | 5 - 4,5 mm                 | 19,80 | 34 |
| 100407.06                    | 407                      | 6 - 5,5 mm                 | 19,80 | 34 |
| 100407.07                    | 407                      | 7 - 6,5 mm                 | 19,80 | 34 |
| 100407.08                    | 407                      | 8 - 7,5 mm                 | 19,80 | 34 |
| 100407.09                    | 407                      | 9 - 8,5 mm                 | 19,80 | 34 |
| 100407.10                    | 407                      | 10 - 9,5 mm                | 19,80 | 34 |
| 100407.11                    | 407                      | 11 - 10,5 mm               | 19,80 | 34 |
| 100407.12                    | 407                      | 12 - 11,5 mm               | 19,80 | 34 |

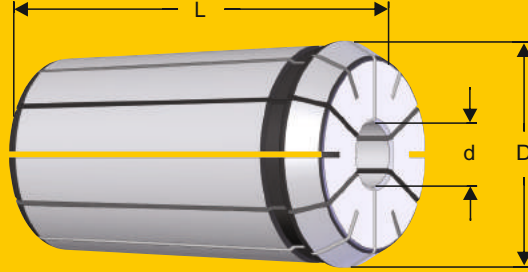

Sayfa : G-01  
Page : G-01



Sayfa : G-12  
Page : G-12



Sayfa : A-16  
Page : A-16



Sayfa : B-12  
Page : B-12



Sayfa : C-27  
Page : C-27



Sayfa : E-26  
Page : E-26



Sayfa : F-04  
Page : F-04

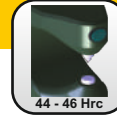

44 - 46 Hrc



VN5

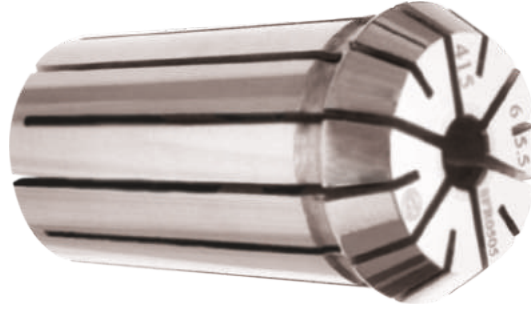

| SİPARİŞ KODU<br>Order Number | ÜRÜN ADI<br>Product Name | KAPASİTE<br>Capacity ( d ) | D    | L  |
|------------------------------|--------------------------|----------------------------|------|----|
| 100415.03                    | 415                      | 3 - 2,5 mm                 | 25,5 | 40 |
| 100415.04                    | 415                      | 4 - 3,5 mm                 | 25,5 | 40 |
| 100415.05                    | 415                      | 5 - 4,5 mm                 | 25,5 | 40 |
| 100415.06                    | 415                      | 6 - 5,5 mm                 | 25,5 | 40 |
| 100415.07                    | 415                      | 7 - 6,5 mm                 | 25,5 | 40 |
| 100415.08                    | 415                      | 8 - 7,5 mm                 | 25,5 | 40 |
| 100415.09                    | 415                      | 9 - 8,5 mm                 | 25,5 | 40 |
| 100415.10                    | 415                      | 10 - 9,5 mm                | 25,5 | 40 |
| 100415.11                    | 415                      | 11 - 10,5 mm               | 25,5 | 40 |
| 100415.12                    | 415                      | 12 - 11,5 mm               | 25,5 | 40 |
| 100415.13                    | 415                      | 13 - 12,5 mm               | 25,5 | 40 |
| 100415.14                    | 415                      | 14 - 13,5 mm               | 25,5 | 40 |
| 100415.15                    | 415                      | 15 - 14,5 mm               | 25,5 | 40 |
| 100415.16                    | 415                      | 16 - 15,5 mm               | 25,5 | 40 |

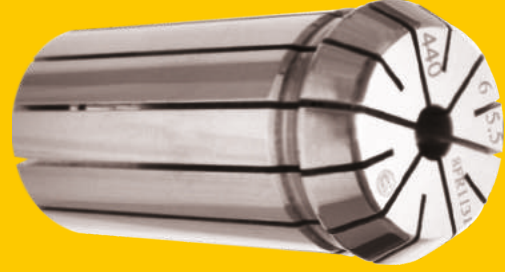
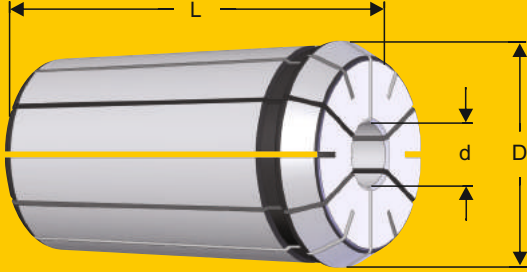

Sayfa : G-01  
Page : G-01



Sayfa : G-12  
Page : G-12



Sayfa : A-16  
Page : A-16

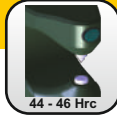

44 - 46 Hrc



VN5

| SİPARİŞ KODU<br>Order Number | ÜRÜN ADI<br>Product Name | KAPASİTE<br>Capacity ( d ) | D     | L  |
|------------------------------|--------------------------|----------------------------|-------|----|
| 100440.03                    | 440                      | 3 - 2,5 mm                 | 29,80 | 45 |
| 100440.04                    | 440                      | 4 - 3,5 mm                 | 29,80 | 45 |
| 100440.05                    | 440                      | 5 - 4,5 mm                 | 29,80 | 45 |
| 100440.06                    | 440                      | 6 - 5,5 mm                 | 29,80 | 45 |
| 100440.07                    | 440                      | 7 - 6,5 mm                 | 29,80 | 45 |
| 100440.08                    | 440                      | 8 - 7,5 mm                 | 29,80 | 45 |
| 100440.09                    | 440                      | 9 - 8,5 mm                 | 29,80 | 45 |
| 100440.10                    | 440                      | 10 - 9,5 mm                | 29,80 | 45 |
| 100440.11                    | 440                      | 11 - 10,5 mm               | 29,80 | 45 |
| 100440.12                    | 440                      | 12 - 11,5 mm               | 29,80 | 45 |
| 100440.13                    | 440                      | 13 - 12,5 mm               | 29,80 | 45 |
| 100440.14                    | 440                      | 14 - 13,5 mm               | 29,80 | 45 |
| 100440.15                    | 440                      | 15 - 14,5 mm               | 29,80 | 45 |
| 100440.16                    | 440                      | 16 - 15,5 mm               | 29,80 | 45 |
| 100440.17                    | 440                      | 17 - 16,5 mm               | 29,80 | 45 |
| 100440.18                    | 440                      | 18 - 17,5 mm               | 29,80 | 45 |
| 100440.19                    | 440                      | 19 - 18,5 mm               | 29,80 | 45 |
| 100440.20                    | 440                      | 20 - 19,5 mm               | 29,80 | 45 |

# DIN 6388 / FORM B

PENS  
Collet



# DEĞERLİ®

www.degerlimakina.com

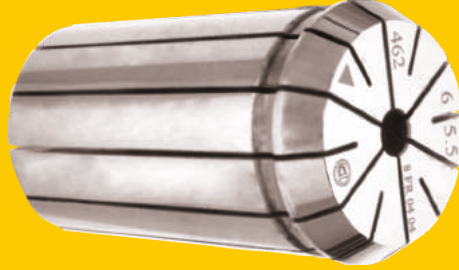
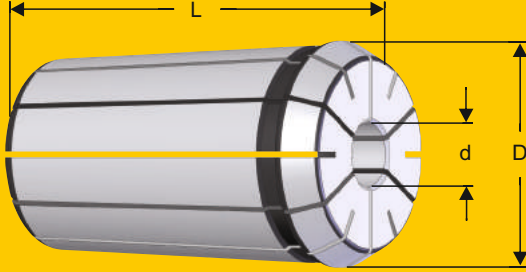

Sayfa : G-01  
Page : G-01



Sayfa : G-12  
Page : G-12



Sayfa : A-16  
Page : A-16



Sayfa : B-12  
Page : B-12



Sayfa : C-27  
Page : C-27



Sayfa : E-26  
Page : E-26



Sayfa : F-04  
Page : F-04



Sayfa : F-08  
Page : F-08

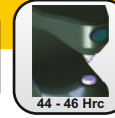

44 - 46 Hrc



VNS

| SİPARİŞ KODU<br>Order Number | ÜRÜN ADI<br>Product Name | KAPASİTE<br>Capacity ( d ) | D     | L  |
|------------------------------|--------------------------|----------------------------|-------|----|
| 100462.04                    | 462                      | 4 - 3,5 mm                 | 35,05 | 52 |
| 100462.05                    | 462                      | 5 - 4,5 mm                 | 35,05 | 52 |
| 100462.06                    | 462                      | 6 - 5,5 mm                 | 35,05 | 52 |
| 100462.07                    | 462                      | 7 - 6,5 mm                 | 35,05 | 52 |
| 100462.08                    | 462                      | 8 - 7,5 mm                 | 35,05 | 52 |
| 100462.09                    | 462                      | 9 - 8,5 mm                 | 35,05 | 52 |
| 100462.10                    | 462                      | 10 - 9,5 mm                | 35,05 | 52 |
| 100462.11                    | 462                      | 11 - 10,5 mm               | 35,05 | 52 |
| 100462.12                    | 462                      | 12 - 11,5 mm               | 35,05 | 52 |
| 100462.14                    | 462                      | 14 - 13,5 mm               | 35,05 | 52 |
| 100462.16                    | 462                      | 16 - 15,5 mm               | 35,05 | 52 |
| 100462.18                    | 462                      | 18 - 17,5 mm               | 35,05 | 52 |
| 100462.20                    | 462                      | 20 - 19,5 mm               | 35,05 | 52 |
| 100462.22                    | 462                      | 22 - 21,5 mm               | 35,05 | 52 |
| 100462.24                    | 462                      | 24 - 23,5 mm               | 35,05 | 52 |
| 100462.25                    | 462                      | 25 - 24,5 mm               | 35,05 | 52 |

HARİCİ ÖLÇÜLER : 2 mm, 3-2,5 mm, 13-12,5 mm - 15-14,5 mm - 17-16,5 mm - 19-18,5 mm - 21-20,5 mm - 23-22,5 mm  
( External Dimension )



# DIN 6388 / FORM B

PENS  
Collet



# DEĞERLİ®

www.degerlimakina.com

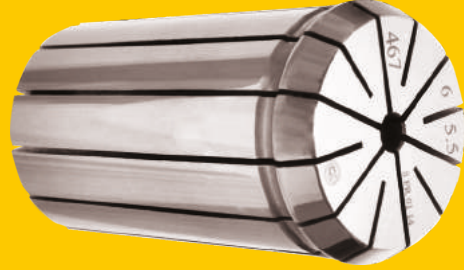
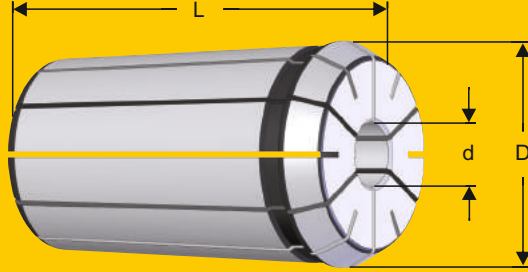

Sayfa : G-01  
Page : G-01



Sayfa : G-12  
Page : G-12



Sayfa : A-16  
Page : A-16



Sayfa : B-12  
Page : B-12

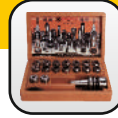

Sayfa : C-27  
Page : C-27



Sayfa : E-26  
Page : E-26



Sayfa : F-04  
Page : F-04



Sayfa : F-08  
Page : F-08

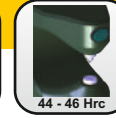

44 - 46 Hrc



VNS

| SİPARİŞ KODU<br>Order Number | ÜRÜN ADI<br>Product Name | KAPASİTE<br>Capacity ( d ) | D    | L  |
|------------------------------|--------------------------|----------------------------|------|----|
| 100467.05                    | 467                      | 5 - 4,5 mm                 | 43,7 | 60 |
| 100467.06                    | 467                      | 6 - 5,5 mm                 | 43,7 | 60 |
| 100467.07                    | 467                      | 7 - 6,5 mm                 | 43,7 | 60 |
| 100467.08                    | 467                      | 8 - 7,5 mm                 | 43,7 | 60 |
| 100467.09                    | 467                      | 9 - 8,5 mm                 | 43,7 | 60 |
| 100467.10                    | 467                      | 10 - 9,5 mm                | 43,7 | 60 |
| 100467.11                    | 467                      | 11 - 10,5 mm               | 43,7 | 60 |
| 100467.12                    | 467                      | 12 - 11,5 mm               | 43,7 | 60 |
| 100467.14                    | 467                      | 14 - 13,5 mm               | 43,7 | 60 |
| 100467.16                    | 467                      | 16 - 15,5 mm               | 43,7 | 60 |
| 100467.18                    | 467                      | 18 - 17,5 mm               | 43,7 | 60 |
| 100467.20                    | 467                      | 20 - 19,5 mm               | 43,7 | 60 |
| 100467.22                    | 467                      | 22 - 21,5 mm               | 43,7 | 60 |
| 100467.24                    | 467                      | 24 - 23,5 mm               | 43,7 | 60 |
| 100467.25                    | 467                      | 25 - 24,5 mm               | 43,7 | 60 |
| 100467.28                    | 467                      | 28 - 27,5 mm               | 43,7 | 60 |
| 100467.30                    | 467                      | 30 - 29,5 mm               | 43,7 | 60 |
| 100467.32                    | 467                      | 32 - 31,5 mm               | 43,7 | 60 |

HARİCİ ÖLÇÜLER : 3-2,5 mm - 4-3,5 mm - 13-12,5 mm - 15-14,5 mm - 17-16,5 mm - 19-18,5 mm - 21-20,5 mm -  
( External Dimension ) 23-22,5 mm - 26-25,5 mm - 27-26,5 mm - 29-28,5 mm - 31-30,5 mm

# DIN 6388 / FORM B

PENS  
Collet



# DEĞERLİ®

www.degerlimakina.com

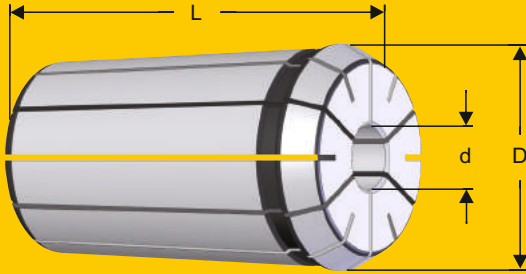

Sayfa : G-01  
Page : G-01



Sayfa : G-12  
Page : G-12



Sayfa : A-16  
Page : A-16



Sayfa : B-12  
Page : B-12

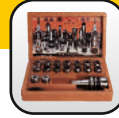

Sayfa : C-27  
Page : C-27

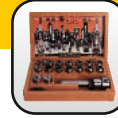

Sayfa : F-04  
Page : F-04



Sayfa : F-08  
Page : F-08

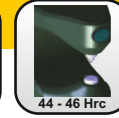

44 - 46 Hrc



VN5

| SİPARİŞ KODU<br>Order Number | ÜRÜN ADI<br>Product Name | KAPASİTE<br>Capacity ( d ) | D    | L  |
|------------------------------|--------------------------|----------------------------|------|----|
| 100468.06                    | 468                      | 6 - 5,5 mm                 | 52,2 | 68 |
| 100468.07                    | 468                      | 7 - 6,5 mm                 | 52,2 | 68 |
| 100468.08                    | 468                      | 8 - 7,5 mm                 | 52,2 | 68 |
| 100468.09                    | 468                      | 9 - 8,5 mm                 | 52,2 | 68 |
| 100468.10                    | 468                      | 10 - 9,5 mm                | 52,2 | 68 |
| 100468.12                    | 468                      | 12 - 11,5 mm               | 52,2 | 68 |
| 100468.14                    | 468                      | 14 - 13,5 mm               | 52,2 | 68 |
| 100468.16                    | 468                      | 16 - 15,5 mm               | 52,2 | 68 |
| 100468.18                    | 468                      | 18 - 17,5 mm               | 52,2 | 68 |
| 100468.20                    | 468                      | 20 - 19,5 mm               | 52,2 | 68 |
| 100468.22                    | 468                      | 22 - 21,5 mm               | 52,2 | 68 |
| 100468.24                    | 468                      | 24 - 23,5 mm               | 52,2 | 68 |
| 100468.25                    | 468                      | 25 - 24,5 mm               | 52,2 | 68 |
| 100468.28                    | 468                      | 28 - 27,5 mm               | 52,2 | 68 |
| 100468.30                    | 468                      | 30 - 29,5 mm               | 52,2 | 68 |
| 100468.32                    | 468                      | 32 - 31,5 mm               | 52,2 | 68 |
| 100468.34                    | 468                      | 34 - 33,5 mm               | 52,2 | 68 |
| 100468.36                    | 468                      | 36 - 35,5 mm               | 52,2 | 68 |
| 100468.38                    | 468                      | 38 - 37,5 mm               | 52,2 | 68 |
| 100468.40                    | 468                      | 40 - 39,5 mm               | 52,2 | 68 |

HARİCİ ÖLÇÜLER : 4-3,5 mm - 5-4,5 mm - 11-10,5 mm - 13-12,5 mm - 15-14,5 mm - 17-16,5 mm - 19-18,5 mm - 21-20,5 mm  
( External Dimension ) 23-22,5 mm - 26-25,5 mm - 27-26,5 mm - 29-28,5 mm - 31-30,5 mm - 33-32,5 mm - 35-34,5 mm  
37-36,5 mm - 39-38,5 mm

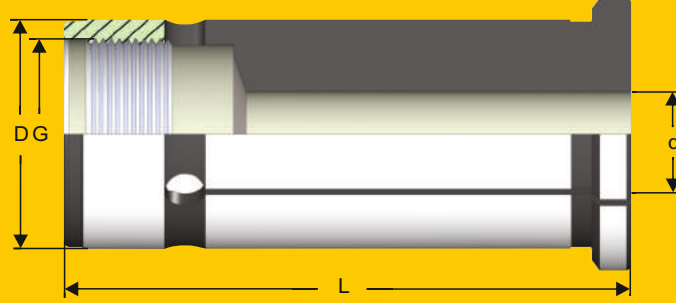

Sayfa : C-07  
Page : C-07



Sayfa : E-07  
Page : E-07



Sayfa : G-01  
Page : G-01



Sayfa : C-29  
Page : C-29



Sayfa : E-28  
Page : E-28

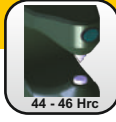

44 - 46 Hrc



V N5

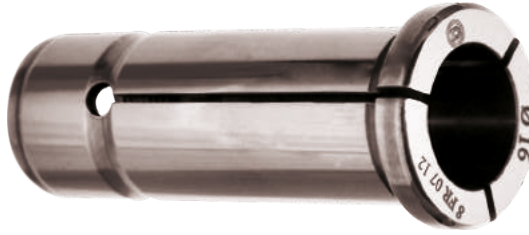

| SİPARİŞ KODU<br>Order Number | ÜRÜN ADI<br>Product Name | d  | D  | L  | G     |
|------------------------------|--------------------------|----|----|----|-------|
| 150020.03                    | RULMANLI TUTUCU PENSİ    | 3  | 20 | 60 | M16x1 |
| 150020.04                    | RULMANLI TUTUCU PENSİ    | 4  | 20 | 60 | M16x1 |
| 150020.05                    | RULMANLI TUTUCU PENSİ    | 5  | 20 | 60 | M16x1 |
| 150020.06                    | RULMANLI TUTUCU PENSİ    | 6  | 20 | 60 | M16x1 |
| 150020.07                    | RULMANLI TUTUCU PENSİ    | 7  | 20 | 60 | M16x1 |
| 150020.08                    | RULMANLI TUTUCU PENSİ    | 8  | 20 | 60 | M16x1 |
| 150020.09                    | RULMANLI TUTUCU PENSİ    | 9  | 20 | 60 | M16x1 |
| 150020.10                    | RULMANLI TUTUCU PENSİ    | 10 | 20 | 60 | M16x1 |
| 150020.11                    | RULMANLI TUTUCU PENSİ    | 11 | 20 | 60 | M16x1 |
| 150020.12                    | RULMANLI TUTUCU PENSİ    | 12 | 20 | 60 | M16x1 |
| 150020.13                    | RULMANLI TUTUCU PENSİ    | 13 | 20 | 60 | M16x1 |
| 150020.14                    | RULMANLI TUTUCU PENSİ    | 14 | 20 | 60 | M16x1 |
| 150020.15                    | RULMANLI TUTUCU PENSİ    | 15 | 20 | 60 | M16x1 |
| 150020.16                    | RULMANLI TUTUCU PENSİ    | 16 | 20 | 60 | M16x1 |

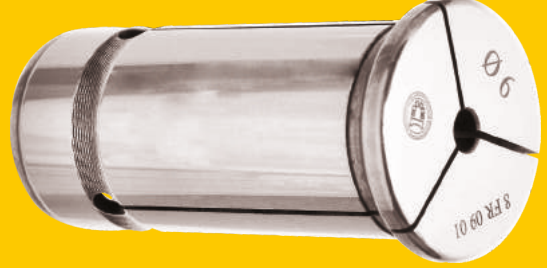
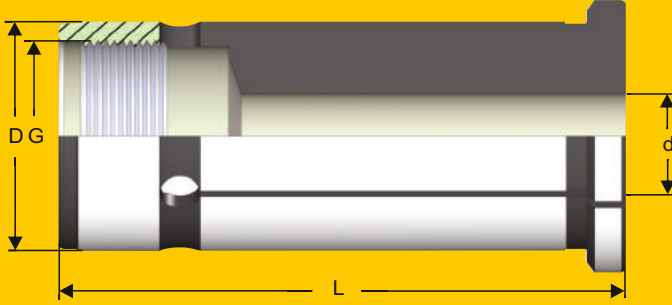

Sayfa : C-07  
Page : C-07



Sayfa : E-07  
Page : E-07



Sayfa : G-01  
Page : G-01



Sayfa : C-29  
Page : C-29



Sayfa : E-28  
Page : E-28

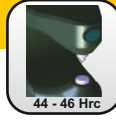

44 - 46 Hrc



V N5

| SİPARİŞ KODU<br>Order Number | ÜRÜN ADI<br>Product Name | d  | D  | L  | G     |
|------------------------------|--------------------------|----|----|----|-------|
| 150032.03                    | RULMANLI TUTUCU PENSİ    | 3  | 32 | 70 | M26x1 |
| 150032.04                    | RULMANLI TUTUCU PENSİ    | 4  | 32 | 70 | M26x1 |
| 150032.05                    | RULMANLI TUTUCU PENSİ    | 5  | 32 | 70 | M26x1 |
| 150032.06                    | RULMANLI TUTUCU PENSİ    | 6  | 32 | 70 | M26x1 |
| 150032.07                    | RULMANLI TUTUCU PENSİ    | 7  | 32 | 70 | M26x1 |
| 150032.08                    | RULMANLI TUTUCU PENSİ    | 8  | 32 | 70 | M26x1 |
| 150032.09                    | RULMANLI TUTUCU PENSİ    | 9  | 32 | 70 | M26x1 |
| 150032.10                    | RULMANLI TUTUCU PENSİ    | 10 | 32 | 70 | M26x1 |
| 150032.11                    | RULMANLI TUTUCU PENSİ    | 11 | 32 | 70 | M26x1 |
| 150032.12                    | RULMANLI TUTUCU PENSİ    | 12 | 32 | 70 | M26x1 |
| 150032.13                    | RULMANLI TUTUCU PENSİ    | 13 | 32 | 70 | M26x1 |
| 150032.14                    | RULMANLI TUTUCU PENSİ    | 14 | 32 | 70 | M26x1 |
| 150032.15                    | RULMANLI TUTUCU PENSİ    | 15 | 32 | 70 | M26x1 |
| 150032.16                    | RULMANLI TUTUCU PENSİ    | 16 | 32 | 70 | M26x1 |
| 150032.17                    | RULMANLI TUTUCU PENSİ    | 17 | 32 | 70 | M26x1 |
| 150032.18                    | RULMANLI TUTUCU PENSİ    | 18 | 32 | 70 | M26x1 |
| 150032.19                    | RULMANLI TUTUCU PENSİ    | 19 | 32 | 70 | M26x1 |
| 150032.20                    | RULMANLI TUTUCU PENSİ    | 20 | 32 | 70 | M26x1 |
| 150032.22                    | RULMANLI TUTUCU PENSİ    | 22 | 32 | 70 | M26x1 |
| 150032.24                    | RULMANLI TUTUCU PENSİ    | 24 | 32 | 70 | M26x1 |
| 150032.25                    | RULMANLI TUTUCU PENSİ    | 25 | 32 | 70 | M26x1 |



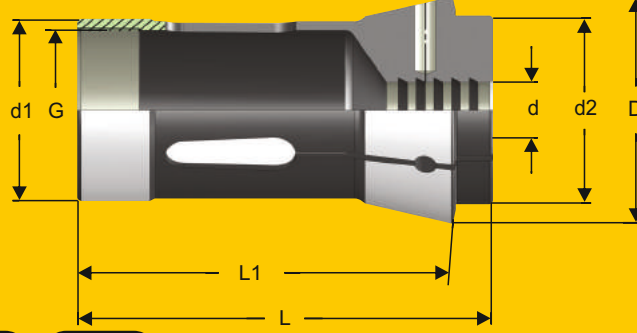

Sayfa : G-03  
Page : G-03



Sayfa : G-04  
Page : G-04

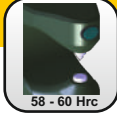

58 - 60 Hrc



VN5



| SİPARİŞ KODU<br>Order Number | ÜRÜN ADI<br>Product Name              | KAPASİTE<br>Capacity ( d ) | d1 | d2 | D  | L1  | L   | G     |
|------------------------------|---------------------------------------|----------------------------|----|----|----|-----|-----|-------|
| 110030.X                     | Ø 163 YUVARLAK PENS / Cylinder Collet | 4.....32 mm                | 35 | 38 | 48 | 72  | 80  | M31x1 |
| 111030.X                     | ⬡ 163 ALTIKÖŞE PENS / Hexagon Collet  | 6.....26 mm                | 35 | 38 | 48 | 72  | 80  | M31x1 |
| 112030.X                     | □ 163 KARE PENS / Square Collet       | 6.....21 mm                | 35 | 38 | 48 | 72  | 80  | M31x1 |
| 110042.X                     | Ø 173 YUVARLAK PENS / Cylinder Collet | 5.....42 mm                | 48 | 50 | 60 | 85  | 94  | M43x1 |
| 111042.X                     | ⬡ 173 ALTIKÖŞE PENS / Hexagon Collet  | 6.....36 mm                | 48 | 50 | 60 | 85  | 94  | M43x1 |
| 112042.X                     | □ 173 KARE PENS / Square Collet       | 6.....29 mm                | 48 | 50 | 60 | 85  | 94  | M43x1 |
| 110060.X                     | Ø 185 YUVARLAK PENS / Cylinder Collet | 6.....60 mm                | 66 | 73 | 84 | 101 | 110 | M61x1 |
| 111060.X                     | ⬡ 185 ALTIKÖŞE PENS / Hexagon Collet  | 8.....52 mm                | 66 | 73 | 84 | 101 | 110 | M61x1 |
| 112060.X                     | □ 185 KARE PENS / Square Collet       | 8.....42 mm                | 66 | 73 | 84 | 101 | 110 | M61x1 |

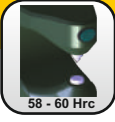
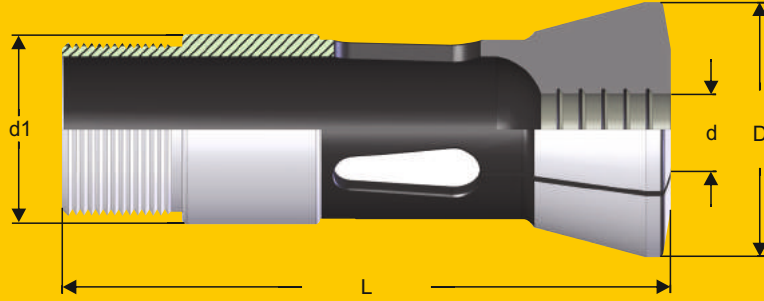

| SİPARİŞ KODU<br>Order Number | ÜRÜN ADI<br>Product Name                   | KAPASİTE<br>Capacity ( d ) | d1 | D    | L   |
|------------------------------|--|----------------------------|----|------|-----|
| 140000.X                     | Ø RAY FENG YUVARLAK PENS / Cylinder Collet | 3.....32 mm                | 43 | 57,5 | 137 |
| 141000.X                     | ⬡ RAY FENG ALTIKÖŞE PENS / Hexagon Collet  | 5.....27 mm                | 43 | 57,5 | 137 |
| 142000.X                     | □ RAY FENG KARE PENS / Square Collet       | 5.....22 mm                | 43 | 57,5 | 137 |

## DIN 6388 FORM B

AHŞAP KUTULU BAŞLIKSIZ PENS TAKIMI  
Collet set in wooden box



# DEĞERLİ®

www.degerlimakina.com



Sayfa : B-02  
Page : B-02



Sayfa : C-02  
Page : C-02



Sayfa : E-02  
Page : E-02



Sayfa : F-02  
Page : F-02



Sayfa : F-06  
Page : F-06

| SİPARİŞ KODU<br>Order Number | ÜRÜN ADI<br>Product Name  | KAPASİTE<br>Capacity | PENS ADEDİ<br>Collet Piece |
|------------------------------|---------------------------|----------------------|----------------------------|
| 000407                       | 407 BAŞLIKSIZ PENS TAKIMI | 3.....12 mm          | 10                         |
| 000415                       | 415 BAŞLIKSIZ PENS TAKIMI | 3.....16 mm          | 12                         |
| 000440                       | 440 BAŞLIKSIZ PENS TAKIMI | 3.....20 mm          | 14                         |
| 000462                       | 462 BAŞLIKSIZ PENS TAKIMI | 4.....25 mm          | 16                         |
| 000467                       | 467 BAŞLIKSIZ PENS TAKIMI | 5.....32 mm          | 16                         |
| 000468                       | 468 BAŞLIKSIZ PENS TAKIMI | 6.....40 mm          | 20                         |

## DIN 6499 ER

AHŞAP KUTULU BAŞLIKSIZ PENS TAKIMI  
Collet set in wooden box



# DEĞERLİ®

www.degerlimakina.com



Sayfa : B-03  
Page : B-03



Sayfa : C-03  
Page : C-03



Sayfa : C-04  
Page : C-04



Sayfa : C-05  
Page : C-05



Sayfa : D01,02,03,04  
Page : D01,02,03,04



Sayfa : D-11  
Page : D-11



Sayfa : E-03  
Page : E-03



Sayfa : E-04  
Page : E-04



Sayfa : E-05  
Page : E-05

| SİPARİŞ KODU<br>Order Number | ÜRÜN ADI<br>Product Name          | KAPASİTE<br>Capacity | PENS ADEDİ<br>Collet Piece |
|------------------------------|-----------------------------------|----------------------|----------------------------|
| 000426                       | ER 16 / 426 BAŞLIKSIZ PENS TAKIMI | 2.....10 mm          | 9                          |
| 000428                       | ER 20 / 428 BAŞLIKSIZ PENS TAKIMI | 2.....12 mm          | 11                         |
| 000430                       | ER 25 / 430 BAŞLIKSIZ PENS TAKIMI | 3.....16 mm          | 12                         |
| 000470                       | ER 32 / 470 BAŞLIKSIZ PENS TAKIMI | 3.....20 mm          | 14                         |
| 000472                       | ER 40 / 472 BAŞLIKSIZ PENS TAKIMI | 4.....26 mm          | 16                         |





| SİPARİŞ KODU<br>Order Number | ÜRÜN ADI<br>Product Name | ADET<br>Piece |
|------------------------------|--------------------------|---------------|
| 100407.03                    | 407 Ø 3 - 2,5 mm         | 1             |
| 100407.04                    | 407 Ø 4 - 3,5 mm         | 1             |
| 100407.05                    | 407 Ø 5 - 4,5 mm         | 1             |
| 100407.06                    | 407 Ø 6 - 5,5 mm         | 1             |
| 100407.07                    | 407 Ø 7 - 6,5 mm         | 1             |
| 100407.08                    | 407 Ø 8 - 7,5 mm         | 1             |
| 100407.09                    | 407 Ø 9 - 8,5 mm         | 1             |
| 100407.10                    | 407 Ø 10 - 9,5 mm        | 1             |
| 100407.11                    | 407 Ø 11 - 10,5 mm       | 1             |
| 100407.12                    | 407 Ø 12 - 11,5 mm       | 1             |

| SİPARİŞ KODU<br>Order Number | ÜRÜN ADI<br>Product Name | ADET<br>Piece |
|------------------------------|--------------------------|---------------|
| 100415.03                    | 415 Ø 3 - 2,5 mm         | 1             |
| 100415.04                    | 415 Ø 4 - 3,5 mm         | 1             |
| 100415.05                    | 415 Ø 5 - 4,5 mm         | 1             |
| 100415.06                    | 415 Ø 6 - 5,5 mm         | 1             |
| 100415.07                    | 415 Ø 7 - 6,5 mm         | 1             |
| 100415.08                    | 415 Ø 8 - 7,5 mm         | 1             |
| 100415.09                    | 415 Ø 9 - 8,5 mm         | 1             |
| 100415.10                    | 415 Ø 10 - 9,5 mm        | 1             |
| 100415.11                    | 415 Ø 11 - 10,5 mm       | 1             |
| 100415.12                    | 415 Ø 12 - 11,5 mm       | 1             |
| 100415.14                    | 415 Ø 14 - 13,5 mm       | 1             |
| 100415.16                    | 415 Ø 16 - 15,5 mm       | 1             |
| 904042                       | 40 - 42 AY ANAHTARI      | 1             |

| SİPARİŞ KODU<br>Order Number | ÜRÜN ADI<br>Product Name | ADET<br>Piece |
|------------------------------|--------------------------|---------------|
| 100440.03                    | 440 Ø 3 - 2,5 mm         | 1             |
| 100440.04                    | 440 Ø 4 - 3,5 mm         | 1             |
| 100440.05                    | 440 Ø 5 - 4,5 mm         | 1             |
| 100440.06                    | 440 Ø 6 - 5,5 mm         | 1             |
| 100440.07                    | 440 Ø 7 - 6,5 mm         | 1             |
| 100440.08                    | 440 Ø 8 - 7,5 mm         | 1             |
| 100440.09                    | 440 Ø 9 - 8,5 mm         | 1             |
| 100440.10                    | 440 Ø 10 - 9,5 mm        | 1             |
| 100440.11                    | 440 Ø 11 - 10,5 mm       | 1             |
| 100440.12                    | 440 Ø 12 - 11,5 mm       | 1             |
| 100440.14                    | 440 Ø 14 - 13,5 mm       | 1             |
| 100440.16                    | 440 Ø 16 - 15,5 mm       | 1             |
| 100440.18                    | 440 Ø 18 - 17,5 mm       | 1             |
| 100440.20                    | 440 Ø 20 - 19,5 mm       | 1             |
| 904550                       | 45 - 50 AY ANAHTARI      | 1             |



| SİPARİŞ KODU<br>Order Number | ÜRÜN ADI<br>Product Name | ADET<br>Piece |
|------------------------------|--------------------------|---------------|
| 100462.04                    | 462 Ø 4 - 3,5 mm         | 1             |
| 100462.05                    | 462 Ø 5 - 4,5 mm         | 1             |
| 100462.06                    | 462 Ø 6 - 5,5 mm         | 1             |
| 100462.07                    | 462 Ø 7 - 6,5 mm         | 1             |
| 100462.08                    | 462 Ø 8 - 7,5 mm         | 1             |
| 100462.09                    | 462 Ø 9 - 8,5 mm         | 1             |
| 100462.10                    | 462 Ø 10 - 9,5 mm        | 1             |
| 100462.11                    | 462 Ø 11 - 10,5 mm       | 1             |
| 100462.12                    | 462 Ø 12 - 11,5 mm       | 1             |
| 100462.14                    | 462 Ø 14 - 13,5 mm       | 1             |
| 100462.16                    | 462 Ø 16 - 15,5 mm       | 1             |
| 100462.18                    | 462 Ø 18 - 17,5 mm       | 1             |
| 100462.20                    | 462 Ø 20 - 19,5 mm       | 1             |
| 100462.22                    | 462 Ø 22 - 21,5 mm       | 1             |
| 100462.24                    | 462 Ø 24 - 23,5 mm       | 1             |
| 100462.25                    | 462 Ø 25 - 24,5 mm       | 1             |
| 905862                       | 58 - 62 AY ANAHTARI      | 1             |

| SİPARİŞ KODU<br>Order Number | ÜRÜN ADI<br>Product Name | ADET<br>Piece |
|------------------------------|--------------------------|---------------|
| 100467.05                    | 467 Ø 5 - 4,5 mm         | 1             |
| 100467.06                    | 467 Ø 6 - 5,5 mm         | 1             |
| 100467.07                    | 467 Ø 7 - 6,5 mm         | 1             |
| 100467.08                    | 467 Ø 8 - 7,5 mm         | 1             |
| 100467.10                    | 467 Ø 10 - 9,5 mm        | 1             |
| 100467.12                    | 467 Ø 12 - 11,5 mm       | 1             |
| 100467.14                    | 467 Ø 14 - 13,5 mm       | 1             |
| 100467.16                    | 467 Ø 16 - 15,5 mm       | 1             |
| 100467.18                    | 467 Ø 18 - 17,5 mm       | 1             |
| 100467.20                    | 467 Ø 20 - 19,5 mm       | 1             |
| 100467.22                    | 467 Ø 22 - 21,5 mm       | 1             |
| 100467.24                    | 467 Ø 24 - 23,5 mm       | 1             |
| 100467.25                    | 467 Ø 25 - 24,5 mm       | 1             |
| 100467.28                    | 467 Ø 28 - 27,5 mm       | 1             |
| 100467.30                    | 467 Ø 30 - 29,5 mm       | 1             |
| 100467.32                    | 467 Ø 32 - 31,5 mm       | 1             |
| 906875                       | 68 - 75 AY ANAHTARI      | 1             |

| SİPARİŞ KODU<br>Order Number | ÜRÜN ADI<br>Product Name | ADET<br>Piece |
|------------------------------|--------------------------|---------------|
| 100468.06                    | 468 Ø 6 - 5,5 mm         | 1             |
| 100468.07                    | 468 Ø 7 - 6,5 mm         | 1             |
| 100468.08                    | 468 Ø 8 - 7,5 mm         | 1             |
| 100468.09                    | 468 Ø 9 - 8,5 mm         | 1             |
| 100468.10                    | 468 Ø 10 - 9,5 mm        | 1             |
| 100468.12                    | 468 Ø 12 - 11,5 mm       | 1             |
| 100468.14                    | 468 Ø 14 - 13,5 mm       | 1             |
| 100468.16                    | 468 Ø 16 - 15,5 mm       | 1             |
| 100468.18                    | 468 Ø 18 - 17,5 mm       | 1             |
| 100468.20                    | 468 Ø 20 - 19,5 mm       | 1             |
| 100468.22                    | 468 Ø 22 - 21,5 mm       | 1             |
| 100468.24                    | 468 Ø 24 - 23,5 mm       | 1             |
| 100468.25                    | 468 Ø 25 - 24,5 mm       | 1             |
| 100468.28                    | 468 Ø 28 - 27,5 mm       | 1             |
| 100468.30                    | 468 Ø 30 - 29,5 mm       | 1             |
| 100468.32                    | 468 Ø 32 - 31,5 mm       | 1             |
| 100468.34                    | 468 Ø 34 - 33,5 mm       | 1             |
| 100468.36                    | 468 Ø 36 - 35,5 mm       | 1             |
| 100468.38                    | 468 Ø 38 - 37,5 mm       | 1             |
| 100468.40                    | 468 Ø 40 - 39,5 mm       | 1             |
| 908090                       | 80 - 90 AY ANAHTARI      | 1             |



| SİPARİŞ KODU<br>Order Number | ÜRÜN ADI<br>Product Name | ADET<br>Piece |
|------------------------------|--------------------------|---------------|
| 100426.02                    | 426 ER 16 Ø 2 mm         | 1             |
| 100426.03                    | 426 ER 16 Ø 3 - 2 mm     | 1             |
| 100426.04                    | 426 ER 16 Ø 4 - 3 mm     | 1             |
| 100426.05                    | 426 ER 16 Ø 5 - 4 mm     | 1             |
| 100426.06                    | 426 ER 16 Ø 6 - 5 mm     | 1             |
| 100426.07                    | 426 ER 16 Ø 7 - 6 mm     | 1             |
| 100426.08                    | 426 ER 16 Ø 8 - 7 mm     | 1             |
| 100426.09                    | 426 ER 16 Ø 9 - 8 mm     | 1             |
| 100426.10                    | 426 ER 16 Ø 10 - 9 mm    | 1             |

| SİPARİŞ KODU<br>Order Number | ÜRÜN ADI<br>Product Name | ADET<br>Piece |
|------------------------------|--------------------------|---------------|
| 100428.02                    | 428 ER 20 Ø 2 mm         | 1             |
| 100428.03                    | 428 ER 20 Ø 3 - 2 mm     | 1             |
| 100428.04                    | 428 ER 20 Ø 4 - 3 mm     | 1             |
| 100428.05                    | 428 ER 20 Ø 5 - 4 mm     | 1             |
| 100428.06                    | 428 ER 20 Ø 6 - 5 mm     | 1             |
| 100428.07                    | 428 ER 20 Ø 7 - 6 mm     | 1             |
| 100428.08                    | 428 ER 20 Ø 8 - 7 mm     | 1             |
| 100428.09                    | 428 ER 20 Ø 9 - 8 mm     | 1             |
| 100428.10                    | 428 ER 20 Ø 10 - 9 mm    | 1             |
| 100428.11                    | 428 ER 20 Ø 11 - 10 mm   | 1             |
| 100428.12                    | 428 ER 20 Ø 12 - 11 mm   | 1             |



| SİPARİŞ KODU<br>Order Number | ÜRÜN ADI<br>Product Name | ADET<br>Piece |
|------------------------------|--------------------------|---------------|
| 100430.03                    | 430 ER 25 Ø 3 - 2 mm     | 1             |
| 100430.04                    | 430 ER 25 Ø 4 - 3 mm     | 1             |
| 100430.05                    | 430 ER 25 Ø 5 - 4 mm     | 1             |
| 100430.06                    | 430 ER 25 Ø 6 - 5 mm     | 1             |
| 100430.07                    | 430 ER 25 Ø 7 - 6 mm     | 1             |
| 100430.08                    | 430 ER 25 Ø 8 - 7 mm     | 1             |
| 100430.09                    | 430 ER 25 Ø 9 - 8 mm     | 1             |
| 100430.10                    | 430 ER 25 Ø 10 - 9 mm    | 1             |
| 100430.11                    | 430 ER 25 Ø 11 - 10 mm   | 1             |
| 100430.12                    | 430 ER 25 Ø 12 - 11 mm   | 1             |
| 100430.14                    | 430 ER 25 Ø 14 - 13 mm   | 1             |
| 100430.16                    | 430 ER 25 Ø 16 - 15 mm   | 1             |
| 9042430                      | 430 ER 25 ANAHTAR        | 1             |

| SİPARİŞ KODU<br>Order Number | ÜRÜN ADI<br>Product Name | ADET<br>Piece |
|------------------------------|--------------------------|---------------|
| 100470.03                    | 470 ER 32 Ø 3 - 2 mm     | 1             |
| 100470.04                    | 470 ER 32 Ø 4 - 3 mm     | 1             |
| 100470.05                    | 470 ER 32 Ø 5 - 4 mm     | 1             |
| 100470.06                    | 470 ER 32 Ø 6 - 5 mm     | 1             |
| 100470.07                    | 470 ER 32 Ø 7 - 6 mm     | 1             |
| 100470.08                    | 470 ER 32 Ø 8 - 7 mm     | 1             |
| 100470.09                    | 470 ER 32 Ø 9 - 8 mm     | 1             |
| 100470.10                    | 470 ER 32 Ø 10 - 9 mm    | 1             |
| 100470.11                    | 470 ER 32 Ø 11 - 10 mm   | 1             |
| 100470.12                    | 470 ER 32 Ø 12 - 11 mm   | 1             |
| 100470.14                    | 470 ER 32 Ø 14 - 13 mm   | 1             |
| 100470.16                    | 470 ER 32 Ø 16 - 15 mm   | 1             |
| 100470.18                    | 470 ER 32 Ø 18 - 17 mm   | 1             |
| 100470.20                    | 470 ER 32 Ø 20 - 19 mm   | 1             |
| 9050470                      | 470 ER 32 ANAHTAR        | 1             |

| SİPARİŞ KODU<br>Order Number | ÜRÜN ADI<br>Product Name | ADET<br>Piece |
|------------------------------|--------------------------|---------------|
| 100472.04                    | 472 ER 40 Ø 4 - 3 mm     | 1             |
| 100472.05                    | 472 ER 40 Ø 5 - 4 mm     | 1             |
| 100472.06                    | 472 ER 40 Ø 6 - 5 mm     | 1             |
| 100472.07                    | 472 ER 40 Ø 7 - 6 mm     | 1             |
| 100472.08                    | 472 ER 40 Ø 8 - 7 mm     | 1             |
| 100472.09                    | 472 ER 40 Ø 9 - 8 mm     | 1             |
| 100472.10                    | 472 ER 40 Ø 10 - 9 mm    | 1             |
| 100472.11                    | 472 ER 40 Ø 11 - 10 mm   | 1             |
| 100472.12                    | 472 ER 40 Ø 12 - 11 mm   | 1             |
| 100472.14                    | 472 ER 40 Ø 14 - 13 mm   | 1             |
| 100472.16                    | 472 ER 40 Ø 16 - 15 mm   | 1             |
| 100472.18                    | 472 ER 40 Ø 18 - 17 mm   | 1             |
| 100472.20                    | 472 ER 40 Ø 20 - 19 mm   | 1             |
| 100472.22                    | 472 ER 40 Ø 22 - 21 mm   | 1             |
| 100472.24                    | 472 ER 40 Ø 24 - 23 mm   | 1             |
| 100472.26                    | 472 ER 40 Ø 26 - 25 mm   | 1             |
| 9063472                      | 472 ER 40 ANAHTAR        | 1             |





**DIN 2080**

---

**iso başlıklar**

---

**iso toolholders**

---



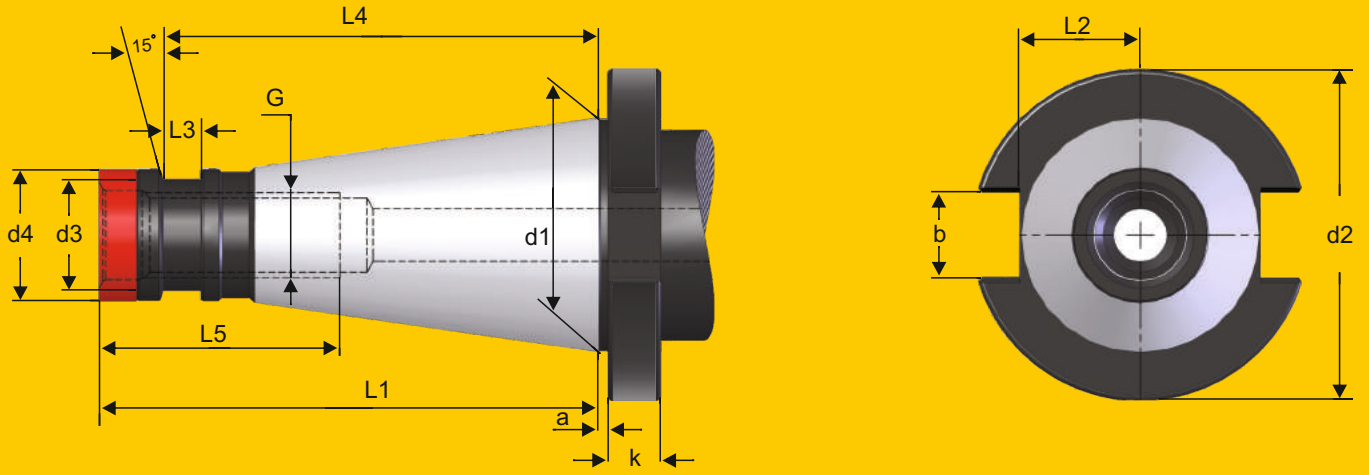

| ÜRÜN ADI<br>Product Name | d1    | a   | b    | k  | G   | d2   | d3   | d4   | L1    | L2   | L3   | L4  | L5 |
|--------------------------|-------|-----|------|----|-----|------|------|------|-------|------|------|-----|----|
| ISO 30                   | 31,75 | 1,6 | 16,1 | 8  | M12 | 50   | ---  | 17,1 | 68,4  | 16,2 | --   | --- | 24 |
| ISO 40                   | 44,45 | 1,6 | 16,1 | 10 | M16 | 63   | 21,1 | 25   | 93,4  | 22,5 | 7    | 82  | 32 |
| ISO 50                   | 69,85 | 3,2 | 25,7 | 12 | M24 | 97,5 | 32   | 39,2 | 126,8 | 35,3 | 13,3 | 115 | 47 |

## DIN 2080

PENS BAŞLIĞI DIN 6391 / PENS 6388

Collet chucks DIN 6391 for Collets DIN 6388



# DEĞERLİ®

www.degerlimakina.com

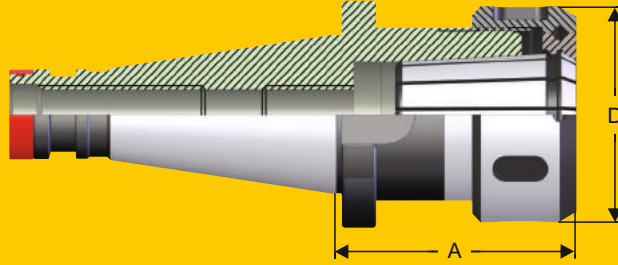

Sayfa : G-01  
Page : G-01



Sayfa / Page :  
A-07,09,10,11



Sayfa : G-12  
Page : G-12



Sayfa : B-12  
Page : B-12



Sayfa : G-10  
Page : G-10



Sayfa : G-11  
Page : G-11

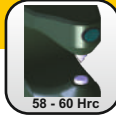

58 - 60 Hrc



V N6



| SİPARİŞ KODU<br>Order Number | ÜRÜN ADI<br>Product Name  | KAPASİTE<br>Capacity | D  | A  |
|------------------------------|---------------------------|----------------------|----|----|
| 210415                       | ISO 30 / 415 PENS BAŞLIĞI | 2.....16 mm          | 43 | 50 |
| 210462                       | ISO 30 / 462 PENS BAŞLIĞI | 2.....25 mm          | 60 | 80 |
| 211415                       | ISO 40 / 415 PENS BAŞLIĞI | 2.....16 mm          | 43 | 55 |
| 211462                       | ISO 40 / 462 PENS BAŞLIĞI | 2.....25 mm          | 60 | 66 |
| 211467                       | ISO 40 / 467 PENS BAŞLIĞI | 3.....32 mm          | 72 | 95 |
| 215462                       | ISO 50 / 462 PENS BAŞLIĞI | 2.....25 mm          | 60 | 71 |
| 215467                       | ISO 50 / 467 PENS BAŞLIĞI | 3.....32 mm          | 72 | 73 |
| 215468                       | ISO 50 / 468 PENS BAŞLIĞI | 3.....40 mm          | 85 | 75 |

## DIN 2080

PENS BAŞLIĞI DIN 6499 ER

Collet chucks for Collet DIN 6499 ER



# DEĞERLİ®

www.degerlimakina.com

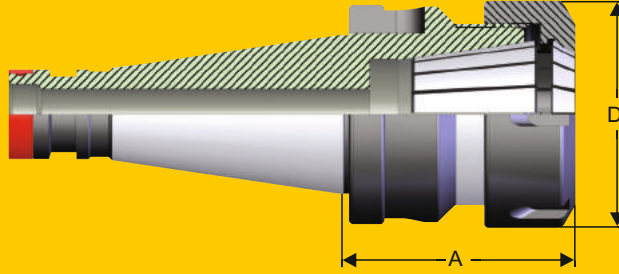

Sayfa : G-02  
Page : G-02



Sayfa : A-03,04,05  
Page : A-03,04,05



Sayfa : G-13  
Page : G-13



Sayfa : B-13  
Page : B-13



Sayfa : G-10  
Page : G-10



Sayfa : G-11  
Page : G-11

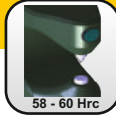

58 - 60 Hrc



V N6



| SİPARİŞ KODU<br>Order Number | ÜRÜN ADI<br>Product Name          | KAPASİTE<br>Capacity | D  | A  |
|------------------------------|-----------------------------------|----------------------|----|----|
| 210430                       | ISO 30 / ER 25 / 430 PENS BAŞLIĞI | 2.....16 mm          | 42 | 50 |
| 210470                       | ISO 30 / ER 32 / 470 PENS BAŞLIĞI | 2.....20 mm          | 50 | 50 |
| 210472                       | ISO 30 / ER 40 / 472 PENS BAŞLIĞI | 2.....26 mm          | 63 | 65 |
| 211430                       | ISO 40 / ER 25 / 430 PENS BAŞLIĞI | 2.....16 mm          | 42 | 50 |
| 211470                       | ISO 40 / ER 32 / 470 PENS BAŞLIĞI | 2.....20 mm          | 50 | 50 |
| 211472                       | ISO 40 / ER 40 / 472 PENS BAŞLIĞI | 2.....26 mm          | 63 | 80 |
| 215470                       | ISO 50 / ER 32 / 470 PENS BAŞLIĞI | 2.....20 mm          | 50 | 63 |
| 215472                       | ISO 50 / ER 40 / 472 PENS BAŞLIĞI | 2.....26 mm          | 63 | 63 |



# DIN 2080

KOMBİNE TARAMA TUTUCUSU DIN 6358  
Combi shell mill holder DIN 6358



# DEĞERLİ®

www.degerlimakina.com

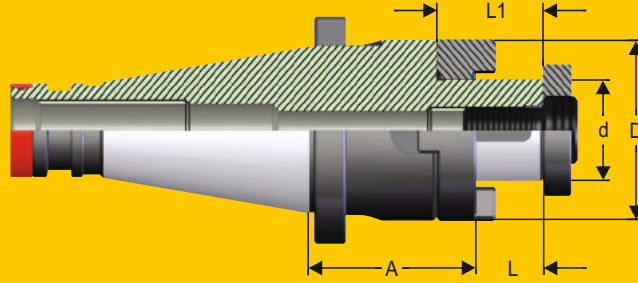

Sayfa : G-08  
Page : G-08



Sayfa : G-09  
Page : G-09



Sayfa : G-10  
Page : G-10



Sayfa : G-11  
Page : G-11

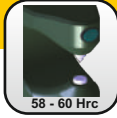

58 - 60 Hrc



VN6



| SİPARİŞ KODU<br>Order Number | ÜRÜN ADI<br>Product Name | d<br>h6 | D  | A  | L  | L1 |
|------------------------------|--------------------------|---------|----|----|----|----|
| 223016                       | ISO 30 / K.T.B. 16       | 16      | 32 | 35 | 17 | 27 |
| 223022                       | ISO 30 / K.T.B. 22       | 22      | 40 | 35 | 19 | 31 |
| 223027                       | ISO 30 / K.T.B. 27       | 27      | 48 | 35 | 21 | 33 |
| 223032                       | ISO 30 / K.T.B. 32       | 32      | 58 | 50 | 24 | 38 |
| 224016                       | ISO 40 / K.T.B. 16       | 16      | 32 | 52 | 17 | 27 |
| 224022                       | ISO 40 / K.T.B. 22       | 22      | 40 | 52 | 19 | 31 |
| 224027                       | ISO 40 / K.T.B. 27       | 27      | 48 | 52 | 21 | 33 |
| 224032                       | ISO 40 / K.T.B. 32       | 32      | 58 | 52 | 24 | 38 |
| 224040                       | ISO 40 / K.T.B. 40       | 40      | 70 | 52 | 27 | 41 |
| 225016                       | ISO 50 / K.T.B. 16       | 16      | 32 | 55 | 17 | 27 |
| 225022                       | ISO 50 / K.T.B. 22       | 22      | 40 | 55 | 19 | 31 |
| 225027                       | ISO 50 / K.T.B. 27       | 27      | 48 | 55 | 21 | 33 |
| 225032                       | ISO 50 / K.T.B. 32       | 32      | 58 | 55 | 24 | 38 |
| 225040                       | ISO 50 / K.T.B. 40       | 40      | 70 | 55 | 27 | 41 |

## DIN 2080

ALIN KAMALI TARAMA TUTUCUSU DIN 6357  
Shell mill holder DIN 6357  
for cutters with driving slot



# DEĞERLİ®

www.degerlimakina.com

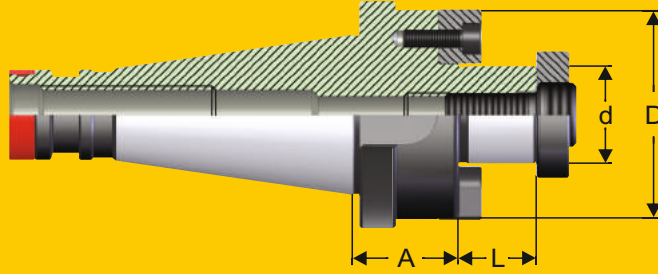

Sayfa : G-08  
Page : G-08



Sayfa : G-10  
Page : G-10



Sayfa : G-11  
Page : G-11

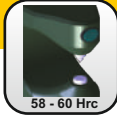

58 - 60 Hrc



V N5

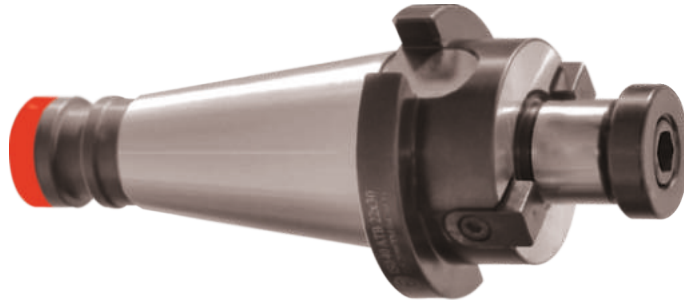

| SİPARİŞ KODU<br>Order Number | ÜRÜN ADI<br>Product Name | d<br>h6 | A  | D   | L  |
|------------------------------|--------------------------|---------|----|-----|----|
| 234016                       | ISO 40 / A.T.B. 16       | 16      | 30 | 38  | 17 |
| 234022                       | ISO 40 / A.T.B. 22       | 22      | 30 | 48  | 19 |
| 234027                       | ISO 40 / A.T.B. 27       | 27      | 30 | 58  | 21 |
| 234032                       | ISO 40 / A.T.B. 32       | 32      | 30 | 78  | 24 |
| 234040                       | ISO 40 / A.T.B. 40       | 40      | 30 | 88  | 27 |
| 235016                       | ISO 50 / A.T.B. 16       | 16      | 35 | 38  | 17 |
| 235022                       | ISO 50 / A.T.B. 22       | 22      | 35 | 48  | 19 |
| 235027                       | ISO 50 / A.T.B. 27       | 27      | 35 | 58  | 21 |
| 235032                       | ISO 50 / A.T.B. 32       | 32      | 40 | 78  | 24 |
| 235040                       | ISO 50 / A.T.B. 40       | 40      | 40 | 88  | 27 |
| 235060                       | ISO 50 / A.T.B. 60       | 60      | 55 | 128 | 40 |

## DIN 2080

WELDON TUTUCU DIN 6359  
SİLİNDİRİK ŞAFTLI DIN 1835-B  
End mill holder DIN 6359  
for weldon type end mills DIN 1835-B



# DEĞERLİ®

www.degerlimakina.com

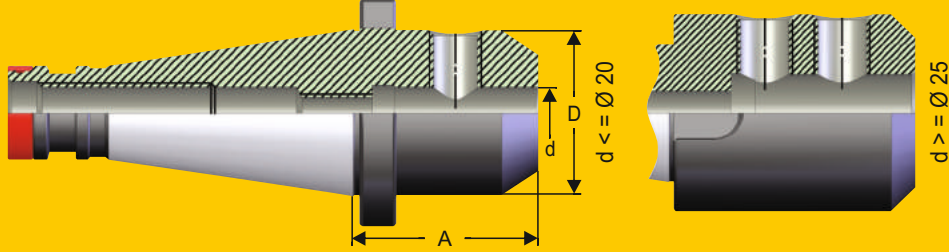

Sayfa : G-20  
Page : G-20



Sayfa : G-10  
Page : G-10



Sayfa : G-11  
Page : G-11

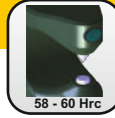

58 - 60 Hrc



VN6



| SİPARİŞ KODU<br>Order Number | ÜRÜN ADI<br>Product Name | d<br>H4 | D  | A  |
|------------------------------|--------------------------|---------|----|----|
| 244006                       | ISO 40 WELDON            | 6       | 25 | 50 |
| 244008                       | ISO 40 WELDON            | 8       | 28 | 50 |
| 244010                       | ISO 40 WELDON            | 10      | 35 | 50 |
| 244012                       | ISO 40 WELDON            | 12      | 42 | 50 |
| 244014                       | ISO 40 WELDON            | 14      | 44 | 50 |
| 244016                       | ISO 40 WELDON            | 16      | 48 | 63 |
| 244018                       | ISO 40 WELDON            | 18      | 50 | 63 |
| 244020                       | ISO 40 WELDON            | 20      | 52 | 63 |
| 244025                       | ISO 40 WELDON            | 25      | 63 | 80 |
| 244032                       | ISO 40 WELDON            | 32      | 72 | 80 |
| 244040                       | ISO 40 WELDON            | 40      | 79 | 90 |

## DIN 2080

WELDON TUTUCU DIN 6359  
SİLİNDİRİK ŞAFTLI DIN 1835-B  
End mill holder DIN 6359  
for weldon type end mills DIN 1835-B



# DEĞERLİ®

www.degerlimakina.com

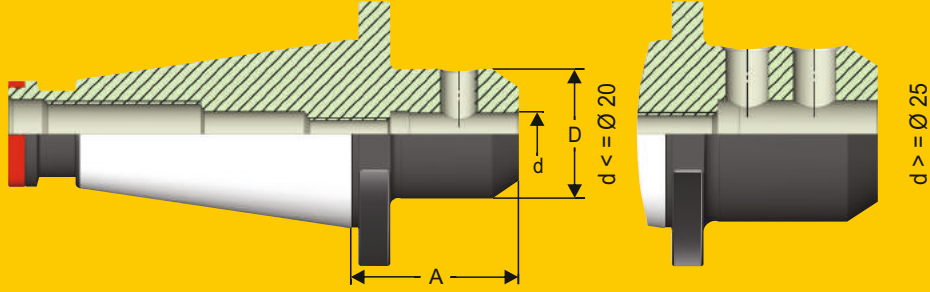

Sayfa : G-20  
Page : G-20



Sayfa : G-10  
Page : G-10



Sayfa : G-11  
Page : G-11

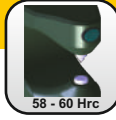

58 - 60 Hrc



VN5



| SİPARİŞ KODU<br>Order Number | ÜRÜN ADI<br>Product Name | d<br>H4 | D  | A  |
|------------------------------|--------------------------|---------|----|----|
| 245006                       | ISO 50 WELDON            | 6       | 25 | 63 |
| 245008                       | ISO 50 WELDON            | 8       | 28 | 63 |
| 245010                       | ISO 50 WELDON            | 10      | 35 | 63 |
| 245012                       | ISO 50 WELDON            | 12      | 42 | 63 |
| 245014                       | ISO 50 WELDON            | 14      | 44 | 63 |
| 245016                       | ISO 50 WELDON            | 16      | 48 | 63 |
| 245018                       | ISO 50 WELDON            | 18      | 50 | 63 |
| 245020                       | ISO 50 WELDON            | 20      | 52 | 63 |
| 245025                       | ISO 50 WELDON            | 25      | 65 | 80 |
| 245032                       | ISO 50 WELDON            | 32      | 72 | 80 |
| 245040                       | ISO 50 WELDON            | 40      | 80 | 90 |



## DIN 2080

KAMALI MORS ADAPTÖRÜ DIN 6383  
Morse taper adaptor tang DIN 6383



# DEĞERLİ®

www.degerlimakina.com

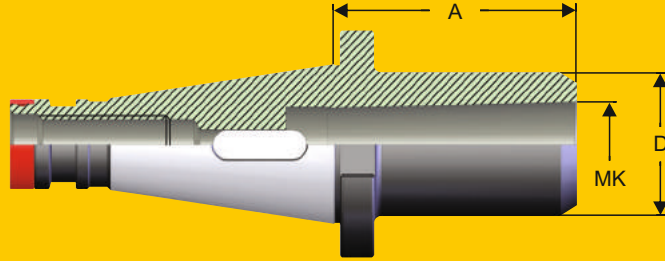

Sayfa : G-10  
Page : G-10



Sayfa : G-11  
Page : G-11

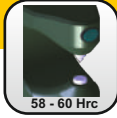

58 - 60 Hrc



V N5



| SİPARİŞ KODU<br>Order Number | ÜRÜN ADI<br>Product Name    | MK<br>Morse | A   | D  |
|------------------------------|-----------------------------|-------------|-----|----|
| 253001                       | ISO 30 KAMALI MORS ADAPTÖRÜ | 1           | 50  | 25 |
| 253002                       | ISO 30 KAMALI MORS ADAPTÖRÜ | 2           | 50  | 32 |
| 253003                       | ISO 30 KAMALI MORS ADAPTÖRÜ | 3           | 75  | 40 |
| 254001                       | ISO 40 KAMALI MORS ADAPTÖRÜ | 1           | 50  | 25 |
| 254002                       | ISO 40 KAMALI MORS ADAPTÖRÜ | 2           | 50  | 32 |
| 254003                       | ISO 40 KAMALI MORS ADAPTÖRÜ | 3           | 65  | 40 |
| 254004                       | ISO 40 KAMALI MORS ADAPTÖRÜ | 4           | 95  | 48 |
| 255001                       | ISO 50 KAMALI MORS ADAPTÖRÜ | 1           | 45  | 25 |
| 255002                       | ISO 50 KAMALI MORS ADAPTÖRÜ | 2           | 60  | 32 |
| 255003                       | ISO 50 KAMALI MORS ADAPTÖRÜ | 3           | 65  | 40 |
| 255004                       | ISO 50 KAMALI MORS ADAPTÖRÜ | 4           | 70  | 48 |
| 255005                       | ISO 50 KAMALI MORS ADAPTÖRÜ | 5           | 105 | 63 |

## DIN 2080

ÇEKTİRMELİ MORS ADAPTÖRÜ DIN 6364  
Morse taper adaptor drawbar DIN 6364



# DEĞERLİ®

www.degerlimakina.com

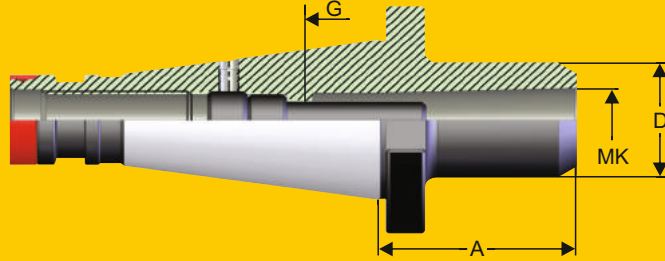

Sayfa : G-10  
Page : G-10



Sayfa : G-11  
Page : G-11

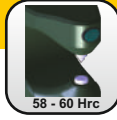

58 - 60 Hrc



VN5



| SİPARİŞ KODU<br>Order Number | ÜRÜN ADI<br>Product Name        | MK<br>Morse | A   | D  | G   |
|------------------------------|---------------------------------|-------------|-----|----|-----|
| 264001                       | ISO 40 ÇEKTİRMELİ MORS ADAPTÖRÜ | 1           | 50  | 25 | M6  |
| 264002                       | ISO 40 ÇEKTİRMELİ MORS ADAPTÖRÜ | 2           | 50  | 32 | M10 |
| 264003                       | ISO 40 ÇEKTİRMELİ MORS ADAPTÖRÜ | 3           | 65  | 40 | M12 |
| 264004                       | ISO 40 ÇEKTİRMELİ MORS ADAPTÖRÜ | 4           | 95  | 48 | M16 |
| 265001                       | ISO 50 ÇEKTİRMELİ MORS ADAPTÖRÜ | 1           | 60  | 25 | M6  |
| 265002                       | ISO 50 ÇEKTİRMELİ MORS ADAPTÖRÜ | 2           | 60  | 32 | M10 |
| 265003                       | ISO 50 ÇEKTİRMELİ MORS ADAPTÖRÜ | 3           | 65  | 40 | M12 |
| 265004                       | ISO 50 ÇEKTİRMELİ MORS ADAPTÖRÜ | 4           | 65  | 48 | M16 |
| 265005                       | ISO 50 ÇEKTİRMELİ MORS ADAPTÖRÜ | 5           | 120 | 63 | M20 |

## DIN 2080

MANDREN BAŞLIĞI DIN 238  
Drill chuck adaptor DIN 238



# DEĞERLİ®

www.degerlimakina.com

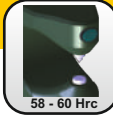
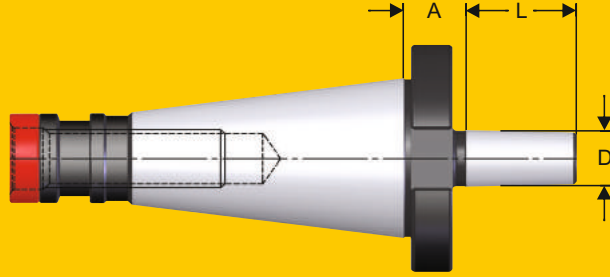

Sayfa : G-10  
Page : G-10

Sayfa : G-11  
Page : G-11

58 - 60 Hrc

VN5



| SİPARİŞ KODU<br>Order Number | ÜRÜN ADI<br>Product Name | D   | A    | L    |
|------------------------------|--------------------------|-----|------|------|
| 273012                       | ISO 30 MANDREN ADAPTÖRÜ  | B12 | 13,5 | 18,5 |
| 273016                       | ISO 30 MANDREN ADAPTÖRÜ  | B16 | 15,5 | 24   |
| 274012                       | ISO 40 MANDREN ADAPTÖRÜ  | B12 | 15   | 18,5 |
| 274016                       | ISO 40 MANDREN ADAPTÖRÜ  | B16 | 17   | 24   |
| 274018                       | ISO 40 MANDREN ADAPTÖRÜ  | B18 | 17   | 32   |
| 275016                       | ISO 50 MANDREN ADAPTÖRÜ  | B16 | 20   | 24   |
| 275018                       | ISO 50 MANDREN ADAPTÖRÜ  | B18 | 20   | 32   |

## DIN 2080

ÇEKTİRME CİVATALI ADAPTÖR  
Adaptor sleeves



# DEĞERLİ®

www.degerlimakina.com

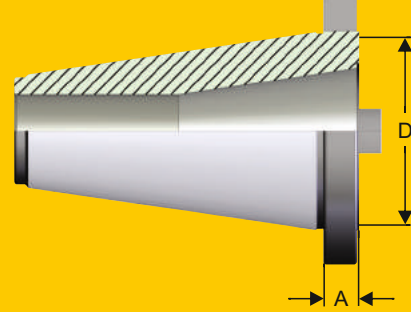
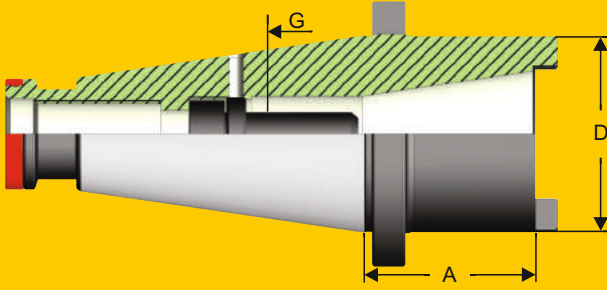

Sayfa : G-10  
Page : G-10



Sayfa : G-11  
Page : G-11

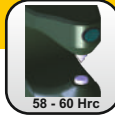

58 - 60 Hrc



VN5



| SİPARİŞ KODU<br>Order Number | ÜRÜN ADI<br>Product Name     | A  | D  | G    |
|------------------------------|------------------------------|----|----|------|
| 284030                       | ISO 40 / ISO 30 ADAPTÖRÜ     | 50 | 50 | M12  |
| 285040                       | ISO 50 / ISO 40 UZUN ADAPTÖR | 60 | 70 | M16  |
| 285040.1                     | ISO 50 / ISO 40 KISA ADAPTÖR | 16 | 70 | ---- |

## DIN 2080

AHŞAP KUTULU PENS TAKIMI DIN 6388-B  
Collet set in wooden box DIN 6388 form B



# DEĞERLİ®

www.degerlimakina.com



Sayfa : G-10  
Page : G-10



Sayfa : G-11  
Page : G-11

| SİPARİŞ KODU<br>Order Number | ÜRÜN ADI<br>Product Name | KAPASİTE<br>Capacity | PENS ADEDİ<br>Collet Piece |
|------------------------------|--------------------------|----------------------|----------------------------|
| 293415                       | ISO 30 / 415 PENS TAKIMI | 3.....16 mm          | 12                         |
| 293462                       | ISO 30 / 462 PENS TAKIMI | 4.....25 mm          | 16                         |
| 294415                       | ISO 40 / 415 PENS TAKIMI | 3.....16 mm          | 12                         |
| 294462                       | ISO 40 / 462 PENS TAKIMI | 4.....25 mm          | 16                         |
| 294467                       | ISO 40 / 467 PENS TAKIMI | 5.....32 mm          | 16                         |
| 295462                       | ISO 50 / 462 PENS TAKIMI | 4.....25 mm          | 16                         |
| 295467                       | ISO 50 / 467 PENS TAKIMI | 5.....32 mm          | 16                         |
| 295468                       | ISO 50 / 468 PENS TAKIMI | 6.....40 mm          | 20                         |



## DIN 2080

AHŞAP KUTULU PENS TAKIMI DIN 6499 ER  
Collet set in wooden box DIN 6499 ER



# DEĞERLİ®

www.degerlimakina.com



Sayfa : G-10  
Page : G-10



Sayfa : G-11  
Page : G-11

| SİPARİŞ KODU<br>Order Number | ÜRÜN ADI<br>Product Name         | KAPASİTE<br>Capacity | PENS ADEDİ<br>Collet Piece |
|------------------------------|----------------------------------|----------------------|----------------------------|
| 293430                       | ISO 30 / ER 25 / 430 PENS TAKIMI | 3.....16 mm          | 14                         |
| 293470                       | ISO 30 / ER 32 / 470 PENS TAKIMI | 3.....20 mm          | 14                         |
| 293472                       | ISO 30 / ER 40 / 472 PENS TAKIMI | 4.....26 mm          | 16                         |
| 294430                       | ISO 40 / ER 25 / 430 PENS TAKIMI | 3.....16 mm          | 14                         |
| 294470                       | ISO 40 / ER 32 / 470 PENS TAKIMI | 3.....20 mm          | 14                         |
| 294472                       | ISO 40 / ER 40 / 472 PENS TAKIMI | 4.....26 mm          | 16                         |
| 295470                       | ISO 50 / ER 32 / 470 PENS TAKIMI | 3.....20 mm          | 14                         |
| 295472                       | ISO 50 / ER 40 / 472 PENS TAKIMI | 4.....26 mm          | 16                         |



**JIS B 6339 (MAS 403 BT)**

**bt başlıklar**

**bt toolholders**



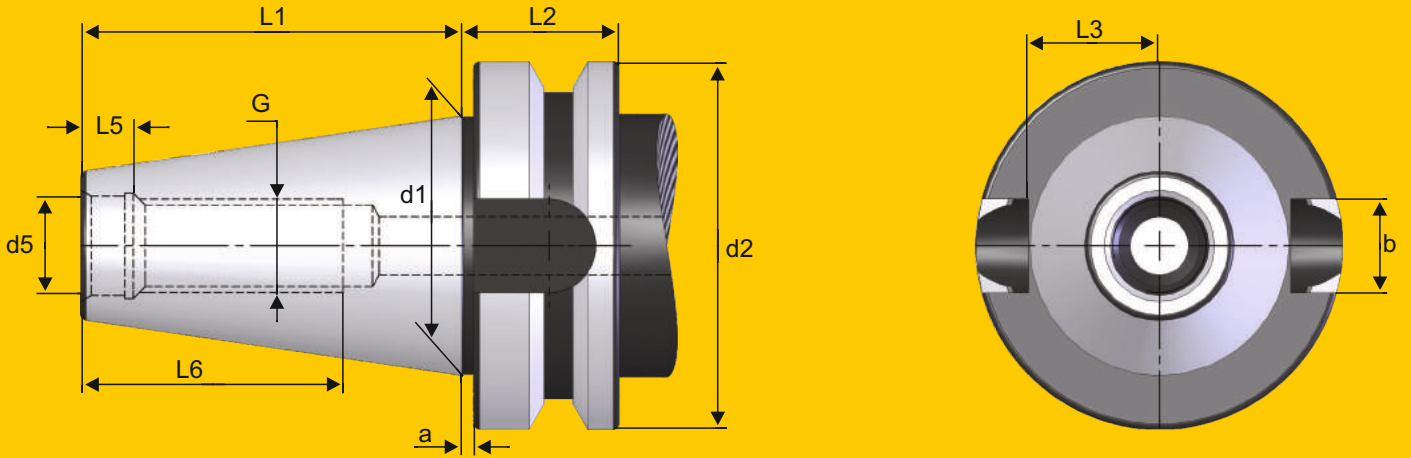

STANDART  
BALANS  
G 6,3  
12000 min<sup>-1</sup>

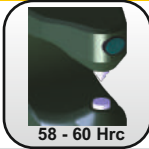

58 - 60 Hrc



VNS

| ÜRÜN ADI<br>Product Name | d1    | G   | d5   | d2  | a | L1    | L2 | L3   | L5  | L6 | b    |
|--------------------------|-------|-----|------|-----|---|-------|----|------|-----|----|------|
| BT 30                    | 31,75 | M12 | 12,5 | 46  | 2 | 48,4  | 22 | 16,3 | 7   | 24 | 16,1 |
| BT 40                    | 44,45 | M16 | 17   | 63  | 2 | 65,4  | 27 | 22,5 | 8,2 | 32 | 16,1 |
| BT 50                    | 69,85 | M24 | 25   | 100 | 3 | 101,8 | 38 | 35,3 | 11  | 47 | 25,7 |



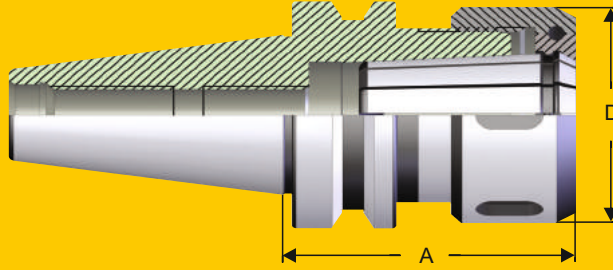

Sayfa / Page :  
G-14,16,17



Sayfa : G-01  
Page : G-01



Sayfa / Page :  
A-07,09,10



Sayfa : G-12  
Page : G-12



Sayfa : C-27  
Page : C-27



Sayfa : G-10  
Page : G-10



Sayfa : G-11  
Page : G-11

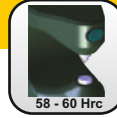

58 - 60 Hrc



VN5



| SİPARİŞ KODU<br>Order Number | ÜRÜN ADI<br>Product Name | KAPASİTE<br>Capacity | D  | A   |
|------------------------------|--------------------------|----------------------|----|-----|
| 310415                       | BT 30 / 415 PENS BAŞLIĞI | 2.....16 mm          | 43 | 60  |
| 310462                       | BT 30 / 462 PENS BAŞLIĞI | 2.....25 mm          | 60 | 80  |
| 311415                       | BT 40 / 415 PENS BAŞLIĞI | 2.....16 mm          | 43 | 70  |
| 311462                       | BT 40 / 462 PENS BAŞLIĞI | 2.....25 mm          | 60 | 70  |
| 311467                       | BT 40 / 467 PENS BAŞLIĞI | 3.....32 mm          | 72 | 90  |
| 315462                       | BT 50 / 462 PENS BAŞLIĞI | 2.....25 mm          | 60 | 85  |
| 315467                       | BT 50 / 467 PENS BAŞLIĞI | 3.....32 mm          | 72 | 90  |
| 315468                       | BT 50 / 468 PENS BAŞLIĞI | 3.....40 mm          | 85 | 100 |

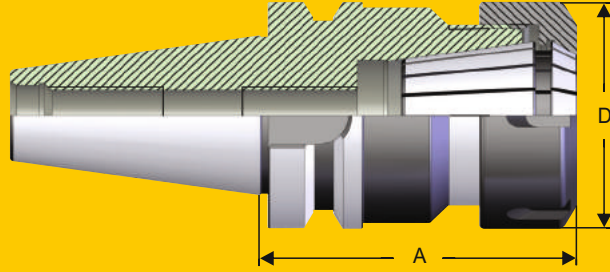

Sayfa / Page :  
G-14,16,17



Sayfa : G-02  
Page : G-02



Sayfa / Page :  
A-01,03,04,05



Sayfa : G-13  
Page : G-13



Sayfa : C-28  
Page : C-28



Sayfa : G-10  
Page : G-10



Sayfa : G-11  
Page : G-11

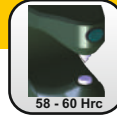

58 - 60 Hrc



Vn5



| SİPARİŞ KODU<br>Order Number | ÜRÜN ADI<br>Product Name       | KAPASİTE<br>Capacity | D  | A  |
|------------------------------|--------------------------------|----------------------|----|----|
| 310426                       | BT 30 ER 16 / 426 PENS BAŞLIĞI | 2.....10 mm          | 32 | 70 |
| 310430                       | BT 30 ER 25 / 430 PENS BAŞLIĞI | 2.....16 mm          | 42 | 70 |
| 310470                       | BT 30 ER 32 / 470 PENS BAŞLIĞI | 2.....20 mm          | 50 | 70 |
| 310472                       | BT 30 ER 40 / 472 PENS BAŞLIĞI | 2.....26 mm          | 63 | 70 |
| 311426                       | BT 40 ER 16 / 426 PENS BAŞLIĞI | 2.....10 mm          | 32 | 63 |
| 311430                       | BT 40 ER 25 / 430 PENS BAŞLIĞI | 2.....16 mm          | 42 | 60 |
| 311470                       | BT 40 ER 32 / 470 PENS BAŞLIĞI | 2.....20 mm          | 50 | 70 |
| 311472                       | BT 40 ER 40 / 472 PENS BAŞLIĞI | 2.....26 mm          | 63 | 80 |
| 315426                       | BT 50 ER 16 / 426 PENS BAŞLIĞI | 2.....10 mm          | 32 | 70 |
| 315430                       | BT 50 ER 25 / 430 PENS BAŞLIĞI | 2.....16 mm          | 42 | 70 |
| 315470                       | BT 50 ER 32 / 470 PENS BAŞLIĞI | 2.....20 mm          | 50 | 70 |
| 315472                       | BT 50 ER 40 / 472 PENS BAŞLIĞI | 2.....26 mm          | 63 | 80 |



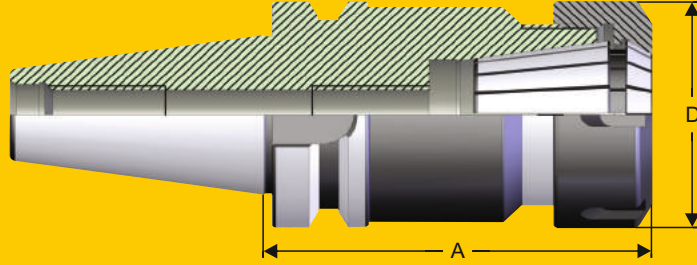

Sayfa / Page :  
G-14,16,17



Sayfa : G-02  
Page : G-02



Sayfa : G-02  
Page : G-02



Sayfa / Page :  
A-01,03,04,05



Sayfa : G-13  
Page : G-13



Sayfa : G-13  
Page : G-13



Sayfa : C-28  
Page : C-28



Sayfa : G-10  
Page : G-10



Sayfa : G-11  
Page : G-11

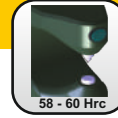

58 - 60 Hrc



VNS



| SİPARİŞ KODU<br>Order Number | ÜRÜN ADI<br>Product Name       | KAPASİTE<br>Capacity | D  | A   |
|------------------------------|--------------------------------|----------------------|----|-----|
| 310426-1                     | BT 30 ER 16 / 426 PENS BAŞLIĞI | 2.....10 mm          | 32 | 100 |
| 310430-1                     | BT 30 ER 25 / 430 PENS BAŞLIĞI | 2.....16 mm          | 42 | 100 |
| 310470-1                     | BT 30 ER 32 / 470 PENS BAŞLIĞI | 2.....20 mm          | 50 | 100 |
| 310472-1                     | BT 30 ER 40 / 472 PENS BAŞLIĞI | 2.....26 mm          | 63 | 100 |
| 312426                       | BT 40 ER 16 / 426 PENS BAŞLIĞI | 2.....10 mm          | 32 | 100 |
| 312426-1                     | BT 40 ER 16 / 426 PENS BAŞLIĞI | 2.....10 mm          | 22 | 100 |
| 312430                       | BT 40 ER 25 / 430 PENS BAŞLIĞI | 2.....16 mm          | 42 | 100 |
| 312470                       | BT 40 ER 32 / 470 PENS BAŞLIĞI | 2.....20 mm          | 50 | 100 |
| 312472                       | BT 40 ER 40 / 472 PENS BAŞLIĞI | 2.....26 mm          | 63 | 100 |
| 316426                       | BT 50 ER 16 / 426 PENS BAŞLIĞI | 2.....10 mm          | 32 | 100 |
| 316430                       | BT 50 ER 25 / 430 PENS BAŞLIĞI | 2.....16 mm          | 42 | 100 |
| 316470                       | BT 50 ER 32 / 470 PENS BAŞLIĞI | 2.....20 mm          | 50 | 100 |
| 316472                       | BT 50 ER 40 / 472 PENS BAŞLIĞI | 2.....26 mm          | 63 | 100 |

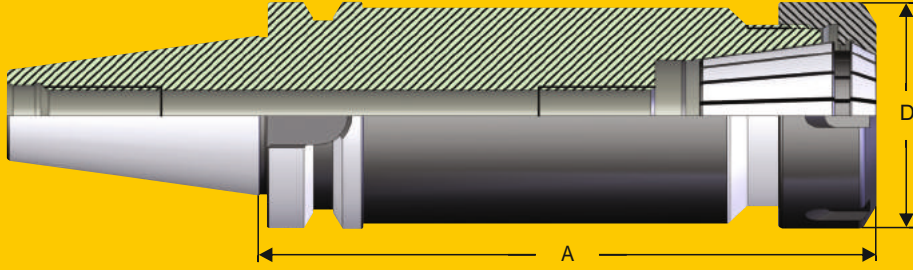

Sayfa / Page :  
G-14,16,17



Sayfa : G-02  
Page : G-02



Sayfa : G-02  
Page : G-02



Sayfa / Page :  
A-01,03,04,05



Sayfa : G-13  
Page : G-13



Sayfa : G-13  
Page : G-13



Sayfa : C-28  
Page : C-28



Sayfa : G-10  
Page : G-10



Sayfa : G-11  
Page : G-11



58 - 60 Hrc



VNS



| SİPARİŞ KODU<br>Order Number | ÜRÜN ADI<br>Product Name       | KAPASİTE<br>Capacity | D  | A   |
|------------------------------|--------------------------------|----------------------|----|-----|
| 313426                       | BT 40 ER 16 / 426 PENS BAŞLIĞI | 2.....10 mm          | 32 | 160 |
| 313426-1                     | BT 40 ER 16 / 426 PENS BAŞLIĞI | 2.....10 mm          | 22 | 160 |
| 313430                       | BT 40 ER 25 / 430 PENS BAŞLIĞI | 2.....16 mm          | 42 | 160 |
| 313470                       | BT 40 ER 32 / 470 PENS BAŞLIĞI | 2.....20 mm          | 50 | 160 |
| 313472                       | BT 40 ER 40 / 472 PENS BAŞLIĞI | 2.....26 mm          | 63 | 160 |
| 317426                       | BT 50 ER 16 / 426 PENS BAŞLIĞI | 2.....10 mm          | 32 | 160 |
| 317426-1                     | BT 50 ER 16 / 426 PENS BAŞLIĞI | 2.....10 mm          | 22 | 160 |
| 317430                       | BT 50 ER 25 / 430 PENS BAŞLIĞI | 2.....16 mm          | 42 | 160 |
| 317470                       | BT 50 ER 32 / 470 PENS BAŞLIĞI | 2.....20 mm          | 50 | 160 |
| 317472                       | BT 50 ER 40 / 472 PENS BAŞLIĞI | 2.....26 mm          | 63 | 160 |

# JIS B 6339 ( MAS 403 BT )

HASSAS AYARLANABİLİR PENS BAŞ.DIN 6499 ER  
Adjustable tool holder DIN 6499 ER



# DEĞERLİ®

www.degerlimakina.com

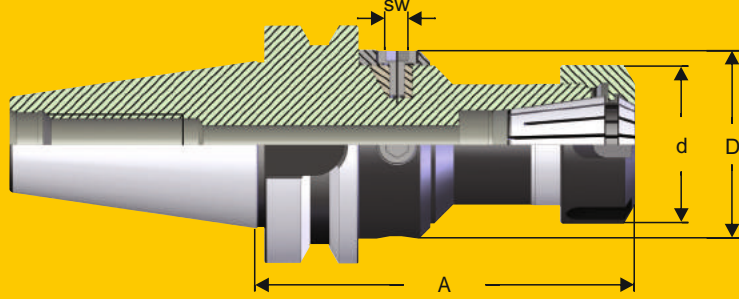

Sayfa / Page :  
G-14,16,17



Sayfa : G-02  
Page : G-02



Sayfa / Page :  
A-03,04,05



Sayfa : G-13  
Page : G-13



Sayfa : C-28  
Page : C-28



Sayfa : G-10  
Page : G-10



Sayfa : G-11  
Page : G-11

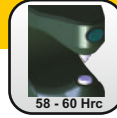

58 - 60 Hrc



VN5



| SİPARİŞ KODU<br>Order Number | ÜRÜN ADI<br>Product Name                | KAPASİTE<br>Capacity | D  | A   | d  | SW |
|------------------------------|---|----------------------|----|-----|----|----|
| 314430                       | BT 40 ER 25 / 430 HAS.AYAR.PENS BAŞLIĞI | 2.....16 mm          | 50 | 90  | 42 | 5  |
| 314470                       | BT 40 ER 32 / 470 HAS.AYAR.PENS BAŞLIĞI | 2.....20 mm          | 50 | 100 | 50 | 5  |
| 314472                       | BT 40 ER 40 / 472 HAS.AYAR.PENS BAŞLIĞI | 2.....26 mm          | 60 | 105 | 63 | 5  |
| 318470                       | BT 50 ER 32 / 470 HAS.AYAR.PENS BAŞLIĞI | 2.....20 mm          | 50 | 110 | 50 | 5  |
| 318472                       | BT 50 ER 40 / HAS.AYAR.472 PENS BAŞLIĞI | 2.....26 mm          | 60 | 115 | 63 | 5  |

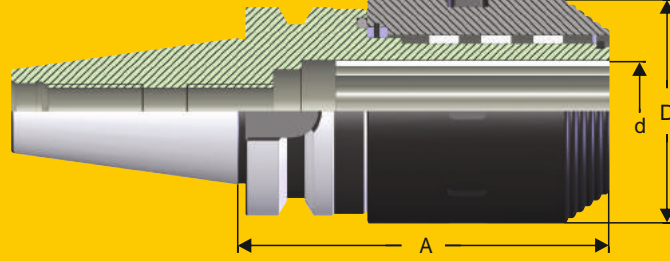

Sayfa / Page :  
G-14,16,17



Sayfa : G-01  
Page : G-01



Sayfa : A-12,13  
Page : A-12,13



Sayfa : C-29  
Page : C-29



Sayfa : G-10  
Page : G-10



Sayfa : G-11  
Page : G-11

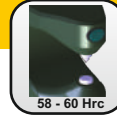

58 - 60 Hrc



VN6



| SİPARİŞ KODU<br>Order Number | ÜRÜN ADI<br>Product Name   | KAPASİTE<br>Capacity<br>( d ) | A  | D  |
|------------------------------|----------------------------|-------------------------------|----|----|
| 318420                       | BT 40 RULMANLI PENS TUTUCU | 6.....20                      | 75 | 49 |
| 318432                       | BT 40 RULMANLI PENS TUTUCU | 6.....32                      | 90 | 68 |
| 319520                       | BT 50 RULMANLI PENS TUTUCU | 6.....20                      | 90 | 49 |
| 319532                       | BT 50 RULMANLI PENS TUTUCU | 6.....32                      | 95 | 68 |

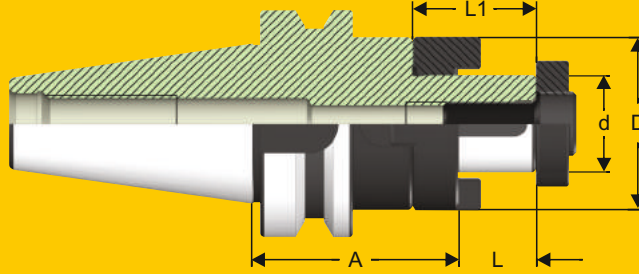

Sayfa / Page :  
G-14,16,17



Sayfa : G-08  
Page : G-08



Sayfa : G-09  
Page : G-09



Sayfa : G-10  
Page : G-10



Sayfa : G-11  
Page : G-11



58 - 60 Hrc



VN5



| SİPARİŞ KODU<br>Order Number | ÜRÜN ADI<br>Product Name | d<br>h6 | D  | A  | L  | L1 |
|------------------------------|--------------------------|---------|----|----|----|----|
| 323016                       | BT 30 / K.T.B. 16        | 16      | 32 | 45 | 17 | 27 |
| 323022                       | BT 30 / K.T.B. 22        | 22      | 40 | 47 | 19 | 31 |
| 323027                       | BT 30 / K.T.B. 27        | 27      | 48 | 49 | 21 | 33 |
| 324016                       | BT 40 / K.T.B. 16        | 16      | 32 | 55 | 17 | 27 |
| 324022                       | BT 40 / K.T.B. 22        | 22      | 40 | 55 | 19 | 31 |
| 324027                       | BT 40 / K.T.B. 27        | 27      | 48 | 55 | 21 | 33 |
| 324032                       | BT 40 / K.T.B. 32        | 32      | 58 | 60 | 24 | 38 |
| 324040                       | BT 40 / K.T.B. 40        | 40      | 70 | 60 | 27 | 41 |
| 325016                       | BT 50 / K.T.B. 16        | 16      | 32 | 70 | 17 | 27 |
| 325022                       | BT 50 / K.T.B. 22        | 22      | 40 | 70 | 19 | 31 |
| 325027                       | BT 50 / K.T.B. 27        | 27      | 48 | 70 | 21 | 33 |
| 325032                       | BT 50 / K.T.B. 32        | 32      | 58 | 70 | 24 | 38 |
| 325040                       | BT 50 / K.T.B. 40        | 40      | 70 | 70 | 27 | 41 |



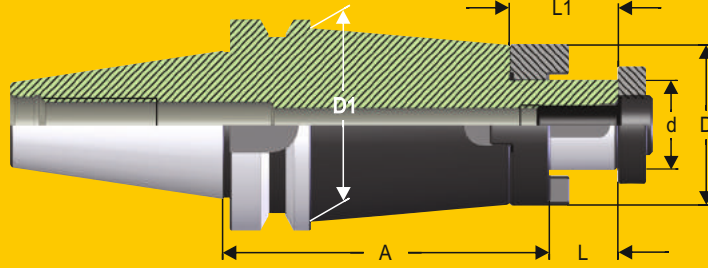

Sayfa / Page :  
G-14,16,17



Sayfa : G-08  
Page : G-08



Sayfa : G-09  
Page : G-09



Sayfa : G-10  
Page : G-10



Sayfa : G-11  
Page : G-11



Sayfa : G-11  
Page : G-11



Sayfa : G-11  
Page : G-11

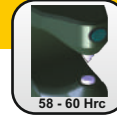

58 - 60 Hrc



VN5



| SİPARİŞ KODU<br>Order Number | ÜRÜN ADI<br>Product Name | d<br>h6 | D  | A   | L  | L1 | D1 |
|------------------------------|--------------------------|---------|----|-----|----|----|----|
| 324116                       | BT 40 / K.T.B. 16        | 16      | 32 | 100 | 17 | 27 | 38 |
| 324122                       | BT 40 / K.T.B. 22        | 22      | 40 | 100 | 19 | 31 | 48 |
| 324127                       | BT 40 / K.T.B. 27        | 27      | 48 | 100 | 21 | 33 | 58 |
| 324132                       | BT 40 / K.T.B. 32        | 32      | 58 | 100 | 24 | 38 | 61 |
| 324140                       | BT 40 / K.T.B. 40        | 40      | 70 | 100 | 27 | 41 | 70 |
| 325116                       | BT 50 / K.T.B. 16        | 16      | 32 | 100 | 17 | 27 | 38 |
| 325122                       | BT 50 / K.T.B. 22        | 22      | 40 | 100 | 19 | 31 | 48 |
| 325127                       | BT 50 / K.T.B. 27        | 27      | 48 | 100 | 21 | 33 | 58 |
| 325132                       | BT 50 / K.T.B. 32        | 32      | 58 | 100 | 24 | 38 | 68 |
| 325140                       | BT 50 / K.T.B. 40        | 40      | 70 | 100 | 27 | 41 | 80 |

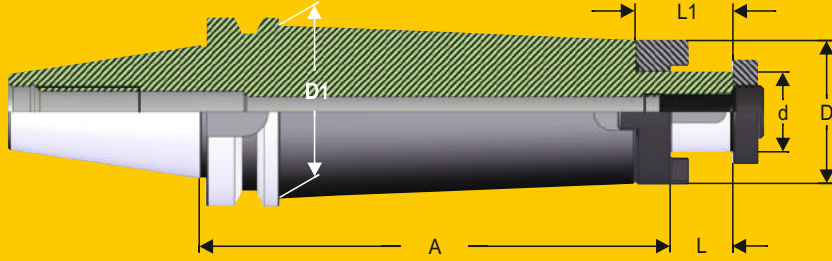

Sayfa / Page :  
G-14,16,17



Sayfa : G-08  
Page : G-08



Sayfa : G-09  
Page : G-09



Sayfa : G-10  
Page : G-10



Sayfa : G-11  
Page : G-11



Sayfa : G-11  
Page : G-11

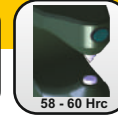

| SİPARİŞ KODU<br>Order Number | ÜRÜN ADI<br>Product Name | d<br>h6 | D  | A   | L  | L1 | D1 |
|------------------------------|--------------------------|---------|----|-----|----|----|----|
| 324116.1                     | BT 40 / K.T.B. 16        | 16      | 32 | 160 | 17 | 27 | 38 |
| 324122.1                     | BT 40 / K.T.B. 22        | 22      | 40 | 160 | 19 | 31 | 48 |
| 324127.1                     | BT 40 / K.T.B. 27        | 27      | 48 | 160 | 21 | 33 | 58 |
| 324132.1                     | BT 40 / K.T.B. 32        | 32      | 58 | 160 | 24 | 38 | 61 |
| 324140.1                     | BT 40 / K.T.B. 40        | 40      | 70 | 160 | 27 | 41 | 70 |
| 325116.1                     | BT 50 / K.T.B. 16        | 16      | 32 | 160 | 17 | 27 | 38 |
| 325122.1                     | BT 50 / K.T.B. 22        | 22      | 40 | 160 | 19 | 31 | 48 |
| 325127.1                     | BT 50 / K.T.B. 27        | 27      | 48 | 160 | 21 | 33 | 58 |
| 325132.1                     | BT 50 / K.T.B. 32        | 32      | 58 | 160 | 24 | 38 | 68 |
| 325140.1                     | BT 50 / K.T.B. 40        | 40      | 70 | 160 | 27 | 41 | 80 |

# JIS B 6339 ( MAS 403 BT )

ALIN KAMALI MALAFA DIN 6357

Shell mill holder DIN 6357  
for cutters with driving slot



# DEĞERLİ®

www.degerlimakina.com

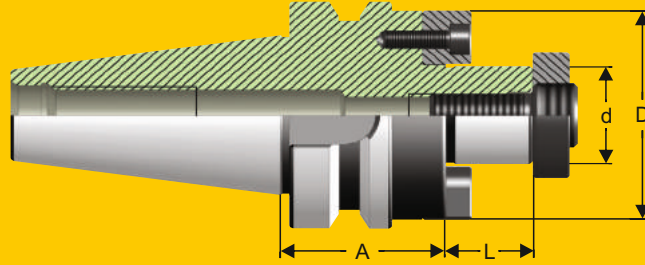

Sayfa / Page :  
G-14,16,17



Sayfa : G-08  
Page : G-08



Sayfa : G-10  
Page : G-10



Sayfa : G-11  
Page : G-11

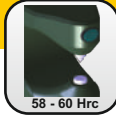

58 - 60 Hrc



V N5



| SİPARİŞ KODU<br>Order Number | ÜRÜN ADI<br>Product Name | d<br>h6 | D   | A  | L  |
|------------------------------|--------------------------|---------|-----|----|----|
| 333016                       | BT 30 / A.T.B. 16        | 16      | 38  | 40 | 17 |
| 333022                       | BT 30 / A.T.B. 22        | 22      | 48  | 40 | 19 |
| 333027                       | BT 30 / A.T.B. 27        | 27      | 58  | 40 | 21 |
| 333032                       | BT 30 / A.T.B. 32        | 32      | 78  | 50 | 24 |
| 334016                       | BT 40 / A.T.B. 16        | 16      | 38  | 40 | 17 |
| 334022                       | BT 40 / A.T.B. 22        | 22      | 48  | 40 | 19 |
| 334027                       | BT 40 / A.T.B. 27        | 27      | 58  | 40 | 21 |
| 334032                       | BT 40 / A.T.B. 32        | 32      | 78  | 50 | 24 |
| 334040                       | BT 40 / A.T.B. 40        | 40      | 88  | 50 | 27 |
| 335016                       | BT 50 / A.T.B. 16        | 16      | 38  | 55 | 17 |
| 335022                       | BT 50 / A.T.B. 22        | 22      | 48  | 55 | 19 |
| 335027                       | BT 50 / A.T.B. 27        | 27      | 58  | 55 | 21 |
| 335032                       | BT 50 / A.T.B. 32        | 32      | 78  | 55 | 24 |
| 335040                       | BT 50 / A.T.B. 40        | 40      | 88  | 55 | 27 |
| 335060                       | BT 50 / A.T.B. 60        | 60      | 128 | 80 | 40 |

# JIS B 6339 ( MAS 403 BT )

ALIN KAMALI MALAFA DIN 6357

Shell mill holder DIN 6357  
for cutters with driving slot



# DEĞERLİ®

www.degerlimakina.com

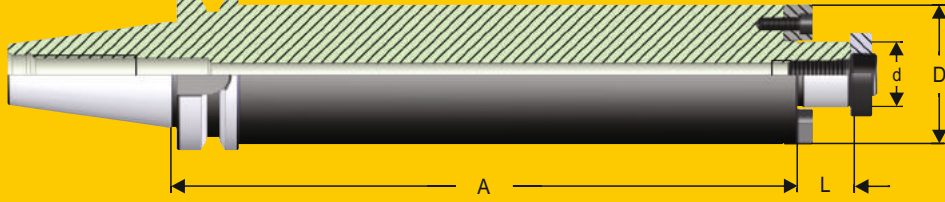

Sayfa / Page :  
G-14,16,17



Sayfa : G-08  
Page : G-08



Sayfa : G-10  
Page : G-10



Sayfa : G-11  
Page : G-11

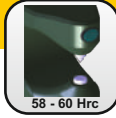

58 - 60 Hrc



V N5



| SİPARİŞ KODU<br>Order Number | ÜRÜN ADI<br>Product Name | d<br>h6 | D  | A   | L  |
|------------------------------|--------------------------|---------|----|-----|----|
| 334322                       | BT 40 / A.T.B. 22        | 22      | 61 | 250 | 19 |
| 334327                       | BT 40 / A.T.B. 27        | 27      | 61 | 250 | 21 |
| 334332                       | BT 40 / A.T.B. 32        | 32      | 78 | 250 | 24 |
| 335322                       | BT 50 / A.T.B. 22        | 22      | 61 | 250 | 19 |
| 335327                       | BT 50 / A.T.B. 27        | 27      | 61 | 250 | 21 |
| 335332                       | BT 50 / A.T.B. 32        | 32      | 78 | 250 | 24 |
| 335422                       | BT 50 / A.T.B. 22        | 22      | 61 | 320 | 19 |
| 335427                       | BT 50 / A.T.B. 27        | 27      | 61 | 320 | 21 |
| 335432                       | BT 50 / A.T.B. 32        | 32      | 78 | 320 | 24 |

# JIS B 6339 ( MAS 403 BT )

WELDON TUTUCU DIN 6359  
SİLİNDİRİK ŞAFTLI DIN 1835-B

End mill holder DIN 6359  
for weldon type end mills DIN 1835-B



# DEĞERLİ®

www.degerlimakina.com

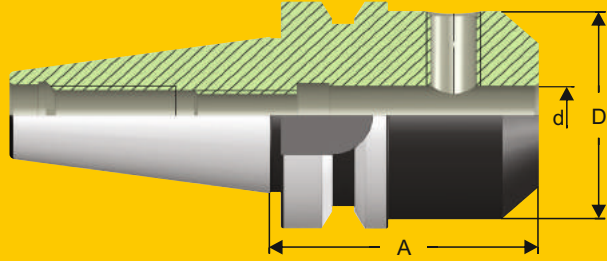

Sayfa / Page :  
G-14,16,17



Sayfa : G-20  
Page : G-20



Sayfa : G-10  
Page : G-10



Sayfa : G-11  
Page : G-11

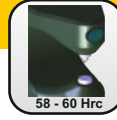

| SİPARİŞ KODU<br>Order Number | ÜRÜN ADI<br>Product Name | d<br>H4 | D  | A  |
|------------------------------|--------------------------|---------|----|----|
| 343006                       | BT 30 WELDON             | 6       | 25 | 50 |
| 343008                       | BT 30 WELDON             | 8       | 28 | 50 |
| 343010                       | BT 30 WELDON             | 10      | 35 | 50 |
| 343012                       | BT 30 WELDON             | 12      | 42 | 50 |
| 343014                       | BT 30 WELDON             | 14      | 44 | 50 |
| 343016                       | BT 30 WELDON             | 16      | 48 | 63 |
| 343018                       | BT 30 WELDON             | 18      | 50 | 63 |
| 343020                       | BT 30 WELDON             | 20      | 52 | 63 |



# JIS B 6339 ( MAS 403 BT )

WELDON TUTUCU DIN 6359  
SİLİNDİRİK ŞAFTLI DIN 1835-B

End mill holder DIN 6359  
for weldon type end mills DIN 1835-B



# DEĞERLİ®

www.degerlimakina.com

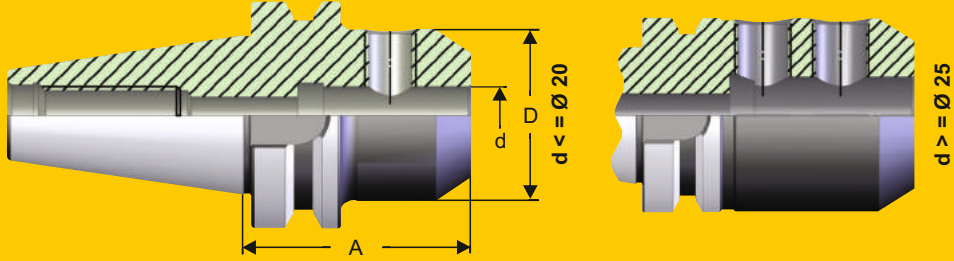

Sayfa / Page :  
G-14,16,17



Sayfa : G-20  
Page : G-20



Sayfa : G-10  
Page : G-10



Sayfa : G-11  
Page : G-11

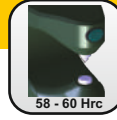

58 - 60 Hrc



VN5



| SİPARİŞ KODU<br>Order Number | ÜRÜN ADI<br>Product Name | d<br>H4 | D  | A   |
|------------------------------|--------------------------|---------|----|-----|
| 344006                       | BT 40 WELDON             | 6       | 25 | 50  |
| 344008                       | BT 40 WELDON             | 8       | 28 | 50  |
| 344010                       | BT 40 WELDON             | 10      | 35 | 63  |
| 344012                       | BT 40 WELDON             | 12      | 42 | 63  |
| 344014                       | BT 40 WELDON             | 14      | 44 | 63  |
| 344016                       | BT 40 WELDON             | 16      | 48 | 63  |
| 344018                       | BT 40 WELDON             | 18      | 50 | 63  |
| 344020                       | BT 40 WELDON             | 20      | 52 | 63  |
| 344025                       | BT 40 WELDON             | 25      | 63 | 90  |
| 344032                       | BT 40 WELDON             | 32      | 72 | 100 |
| 344040                       | BT 40 WELDON             | 40      | 79 | 120 |

# JIS B 6339 ( MAS 403 BT )

WELDON TUTUCU DIN 6359  
SİLİNDİRİK ŞAFTLI DIN 1835-B

End mill holder DIN 6359  
for weldon type end mills DIN 1835-B



# DEĞERLİ®

www.degerlimakina.com

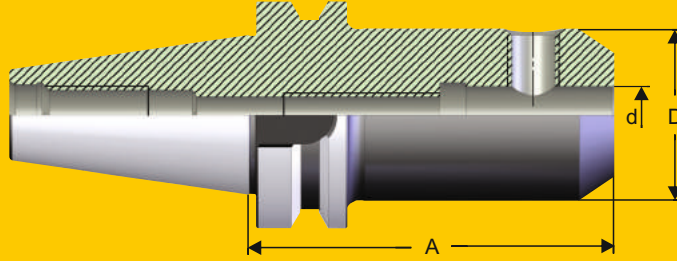

Sayfa / Page :  
G-14,16,17



Sayfa : G-20  
Page : G-20



Sayfa : G-10  
Page : G-10



Sayfa : G-11  
Page : G-11

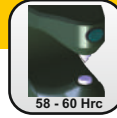

58 - 60 Hrc



VN5



| SİPARİŞ KODU<br>Order Number | ÜRÜN ADI<br>Product Name | d<br>H4 | D  | A   |
|------------------------------|--------------------------|---------|----|-----|
| 344105                       | BT 40 WELDON             | 5       | 25 | 100 |
| 344106                       | BT 40 WELDON             | 6       | 25 | 100 |
| 344108                       | BT 40 WELDON             | 8       | 28 | 100 |
| 344110                       | BT 40 WELDON             | 10      | 35 | 100 |
| 344112                       | BT 40 WELDON             | 12      | 42 | 100 |
| 344114                       | BT 40 WELDON             | 14      | 44 | 100 |
| 344116                       | BT 40 WELDON             | 16      | 48 | 100 |
| 344118                       | BT 40 WELDON             | 18      | 50 | 100 |
| 344120                       | BT 40 WELDON             | 20      | 52 | 100 |

# JIS B 6339 ( MAS 403 BT )

WELDON TUTUCU DIN 6359

SİLİNDİRİK ŞAFTLI DIN 1835-B

End mill holder DIN 6359

for weldon type end mills DIN 1835-B



# DEĞERLİ®

www.degerlimakina.com

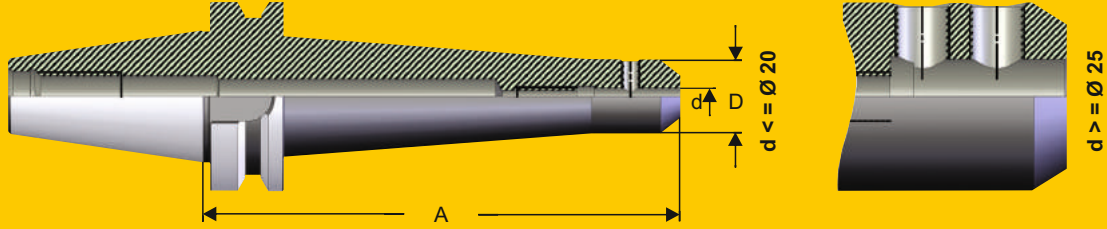

Sayfa / Page :  
G-14,16,17



Sayfa : G-20  
Page : G-20



Sayfa : G-10  
Page : G-10



Sayfa : G-11  
Page : G-11

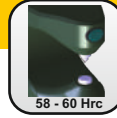

58 - 60 Hrc



VN5

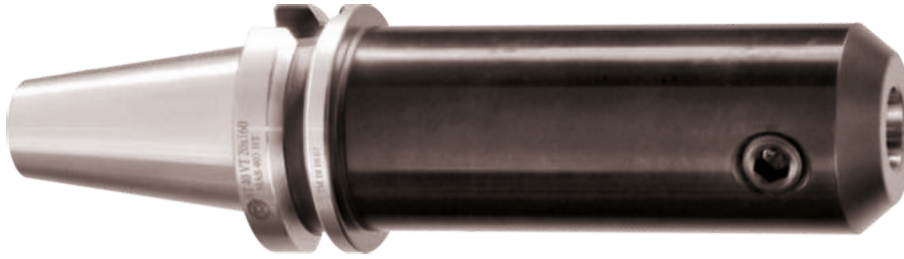

| SİPARİŞ KODU<br>Order Number | ÜRÜN ADI<br>Product Name | d<br>H4 | D  | A   |
|------------------------------|--------------------------|---------|----|-----|
| 344106.1                     | BT 40 WELDON             | 6       | 25 | 160 |
| 344108.1                     | BT 40 WELDON             | 8       | 28 | 160 |
| 344110.1                     | BT 40 WELDON             | 10      | 35 | 160 |
| 344112.1                     | BT 40 WELDON             | 12      | 42 | 160 |
| 344114.1                     | BT 40 WELDON             | 14      | 44 | 160 |
| 344116.1                     | BT 40 WELDON             | 16      | 48 | 160 |
| 344118.1                     | BT 40 WELDON             | 18      | 50 | 160 |
| 344120.1                     | BT 40 WELDON             | 20      | 52 | 160 |
| 344125.1                     | BT 40 WELDON             | 25      | 63 | 160 |
| 344132.1                     | BT 40 WELDON             | 32      | 72 | 160 |

# JIS B 6339 ( MAS 403 BT )

WELDON TUTUCU DIN 6359  
SİLİNDİRİK ŞAFTLI DIN 1835-B

End mill holder DIN 6359  
for weldon type end mills DIN 1835-B



# DEĞERLİ®

www.degerlimakina.com

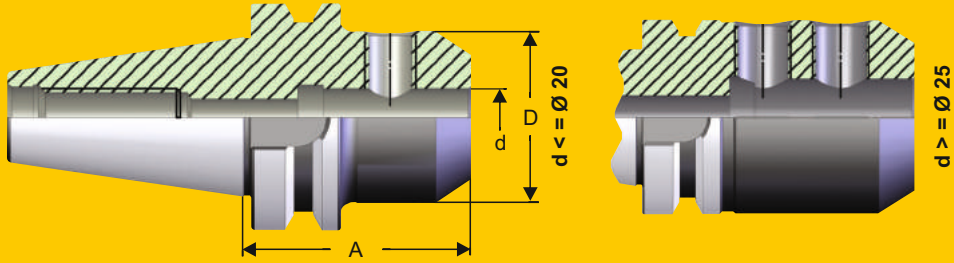

Sayfa / Page :  
G-14,16,17



Sayfa : G-20  
Page : G-20



Sayfa : G-10  
Page : G-10



Sayfa : G-11  
Page : G-11

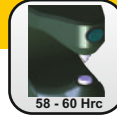

| SİPARİŞ KODU<br>Order Number | ÜRÜN ADI<br>Product Name | d<br>H4 | D  | A   |
|------------------------------|--------------------------|---------|----|-----|
| 345006                       | BT 50 WELDON             | 6       | 25 | 63  |
| 345008                       | BT 50 WELDON             | 8       | 28 | 63  |
| 345010                       | BT 50 WELDON             | 10      | 35 | 63  |
| 345012                       | BT 50 WELDON             | 12      | 42 | 80  |
| 345014                       | BT 50 WELDON             | 14      | 44 | 80  |
| 345016                       | BT 50 WELDON             | 16      | 48 | 80  |
| 345018                       | BT 50 WELDON             | 18      | 50 | 80  |
| 345020                       | BT 50 WELDON             | 20      | 52 | 80  |
| 345025                       | BT 50 WELDON             | 25      | 65 | 100 |
| 345032                       | BT 50 WELDON             | 32      | 72 | 105 |
| 345040                       | BT 50 WELDON             | 40      | 80 | 110 |

# JIS B 6339 ( MAS 403 BT )

WELDON TUTUCU DIN 6359  
SİLİNDİRİK ŞAFTLI DIN 1835-B

End mill holder DIN 6359  
for weldon type end mills DIN 1835-B



# DEĞERLİ®

www.degerlimakina.com

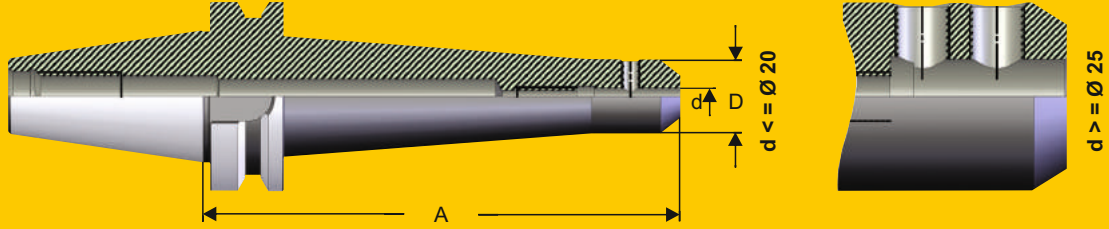

Sayfa / Page :  
G-14,16,17



Sayfa : G-20  
Page : G-20



Sayfa : G-10  
Page : G-10



Sayfa : G-11  
Page : G-11

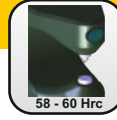

58 - 60 Hrc



VN5

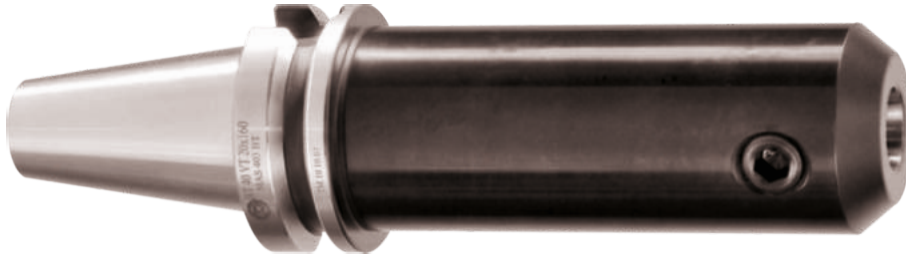

| SİPARİŞ KODU<br>Order Number | ÜRÜN ADI<br>Product Name | d<br>H4 | D  | A   |
|------------------------------|--------------------------|---------|----|-----|
| 345106                       | BT 50 WELDON             | 6       | 25 | 160 |
| 345108                       | BT 50 WELDON             | 8       | 28 | 160 |
| 345110                       | BT 50 WELDON             | 10      | 35 | 160 |
| 345112                       | BT 50 WELDON             | 12      | 42 | 160 |
| 345116                       | BT 50 WELDON             | 16      | 48 | 160 |
| 345120                       | BT 50 WELDON             | 20      | 52 | 160 |
| 345125                       | BT 50 WELDON             | 25      | 65 | 160 |
| 345132                       | BT 50 WELDON             | 32      | 72 | 160 |
| 345140                       | BT 50 WELDON             | 40      | 80 | 160 |



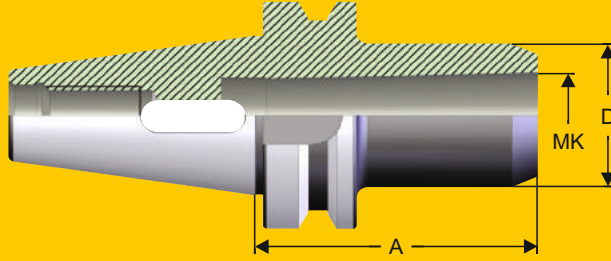

Sayfa / Page :  
G-14,16,17



Sayfa : G-10  
Page : G-10



Sayfa : G-11  
Page : G-11

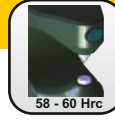

58 - 60 Hrc



V N5



| SİPARİŞ KODU<br>Order Number | ÜRÜN ADI<br>Product Name   | MK<br>Morse | D  | A   |
|------------------------------|----------------------------|-------------|----|-----|
| 353001                       | BT 30 KAMALI MORS ADAPTÖRÜ | 1           | 25 | 45  |
| 353002                       | BT 30 KAMALI MORS ADAPTÖRÜ | 2           | 32 | 60  |
| 353003                       | BT 30 KAMALI MORS ADAPTÖRÜ | 3           | 40 | 75  |
| 354001                       | BT 40 KAMALI MORS ADAPTÖRÜ | 1           | 25 | 50  |
| 354002                       | BT 40 KAMALI MORS ADAPTÖRÜ | 2           | 32 | 50  |
| 354003                       | BT 40 KAMALI MORS ADAPTÖRÜ | 3           | 40 | 70  |
| 354004                       | BT 40 KAMALI MORS ADAPTÖRÜ | 4           | 48 | 95  |
| 355001                       | BT 50 KAMALI MORS ADAPTÖRÜ | 1           | 25 | 45  |
| 355002                       | BT 50 KAMALI MORS ADAPTÖRÜ | 2           | 32 | 60  |
| 355003                       | BT 50 KAMALI MORS ADAPTÖRÜ | 3           | 40 | 65  |
| 355004                       | BT 50 KAMALI MORS ADAPTÖRÜ | 4           | 48 | 95  |
| 355005                       | BT 50 KAMALI MORS ADAPTÖRÜ | 5           | 63 | 105 |

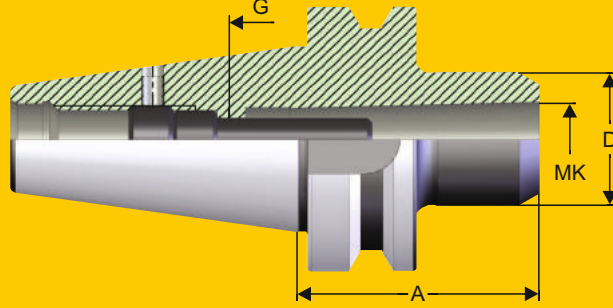

Sayfa / Page :  
G-14,16,17



Sayfa : G-10  
Page : G-10



Sayfa : G-11  
Page : G-11

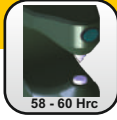

58 - 60 Hrc



V N5



| SİPARİŞ KODU<br>Order Number | ÜRÜN ADI<br>Product Name       | MK<br>Morse | D  | A   | G   |
|------------------------------|--------------------------------|-------------|----|-----|-----|
| 364001                       | BT 40 ÇEKTİRMELİ MORS ADAPTÖRÜ | 1           | 25 | 50  | M6  |
| 364002                       | BT 40 ÇEKTİRMELİ MORS ADAPTÖRÜ | 2           | 32 | 55  | M10 |
| 364003                       | BT 40 ÇEKTİRMELİ MORS ADAPTÖRÜ | 3           | 40 | 70  | M12 |
| 364004                       | BT 40 ÇEKTİRMELİ MORS ADAPTÖRÜ | 4           | 48 | 95  | M16 |
| 365001                       | BT 50 ÇEKTİRMELİ MORS ADAPTÖRÜ | 1           | 25 | 45  | M6  |
| 365002                       | BT 50 ÇEKTİRMELİ MORS ADAPTÖRÜ | 2           | 32 | 60  | M10 |
| 365003                       | BT 50 ÇEKTİRMELİ MORS ADAPTÖRÜ | 3           | 40 | 65  | M12 |
| 365004                       | BT 50 ÇEKTİRMELİ MORS ADAPTÖRÜ | 4           | 48 | 85  | M16 |
| 365005                       | BT 50 ÇEKTİRMELİ MORS ADAPTÖRÜ | 5           | 63 | 118 | M20 |

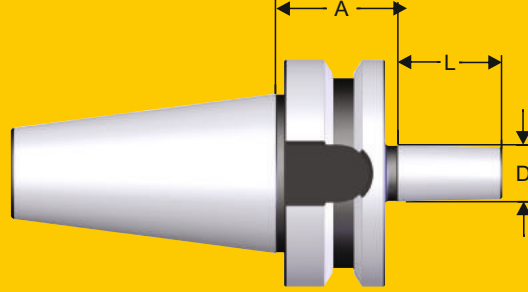

Sayfa / Page :  
G-14,16,17



Sayfa : G-10  
Page : G-10



Sayfa : G-11  
Page : G-11

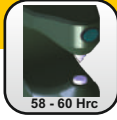

58 - 60 Hrc



V N5



| SİPARİŞ KODU<br>Order Number | ÜRÜN ADI<br>Product Name | D   | A  | L    |
|------------------------------|--------------------------|-----|----|------|
| 373012                       | BT 30 MANDREN ADAPTÖRÜ   | B12 | 25 | 18,5 |
| 373016                       | BT 30 MANDREN ADAPTÖRÜ   | B16 | 25 | 24   |
| 374012                       | BT 40 MANDREN ADAPTÖRÜ   | B12 | 32 | 18,5 |
| 374016                       | BT 40 MANDREN ADAPTÖRÜ   | B16 | 32 | 24   |
| 374018                       | BT 40 MANDREN ADAPTÖRÜ   | B18 | 32 | 32   |
| 375016                       | BT 50 MANDREN ADAPTÖRÜ   | B16 | 43 | 24   |
| 375018                       | BT 50 MANDREN ADAPTÖRÜ   | B18 | 43 | 32   |

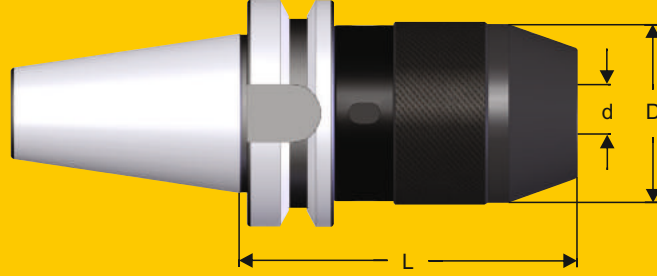

Sayfa / Page :  
G-14,16,17



Sayfa : G-10  
Page : G-10



Sayfa : G-11  
Page : G-11

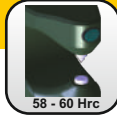

58 - 60 Hrc



VN5



| SİPARİŞ KODU<br>Order Number | ÜRÜN ADI<br>Product Name | KAPASİTE<br>Capacity<br>d | D  | L   |
|------------------------------|--------------------------|---------------------------|----|-----|
| 373116                       | BT 30 NC MANDREN TUTUCU  | 1.....16                  | 51 | 112 |
| 374116                       | BT 40 NC MANDREN TUTUCU  | 1.....16                  | 51 | 97  |
| 375116                       | BT 50 NC MANDREN TUTUCU  | 1.....16                  | 51 | 108 |

# JIS B 6339 ( MAS 403 BT )

KLAVUZ ÇEKME BAŞLIĞI GİRİŞ VE ÇIKIŞ KOMPANZİYELİ  
Quick-change tapping chucks with length compensation



# DEĞERLİ®

www.degerlimakina.com

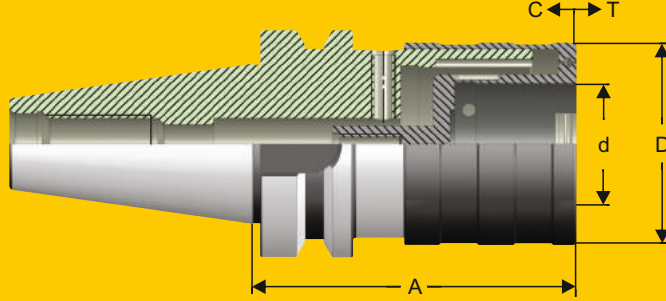

Sayfa / Page :  
G-14,16,17



Sayfa / Page :  
G-05,06,07



Sayfa : G-10  
Page : G-10



Sayfa : G-11  
Page : G-11

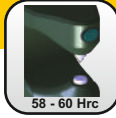

NEW PRODUCT  
YENİ ÜRÜN

| SİPARİŞ KODU<br>Order Number | ÜRÜN ADI<br>Product Name            | d  | A   | D  | C    | T    |
|------------------------------|-------------------------------------|----|-----|----|------|------|
| 376214                       | BT 30 M2 / M14 EM.TİP KLV.ÇEK.BAŞ.  | 19 | 64  | 38 | 7    | 7    |
| 376524                       | BT 30 M5 / M24 EM.TİP KLV.ÇEK.BAŞ.  | 31 | 95  | 54 | 12   | 12   |
| 377214                       | BT 40 M2 / M14 EM.TİP KLV.ÇEK.BAŞ.  | 19 | 67  | 38 | 7    | 7    |
| 377524                       | BT 40 M5 / M24 EM.TİP KLV.ÇEK.BAŞ.  | 31 | 93  | 54 | 12   | 12   |
| 3771436                      | BT 40 M14 / M36 EM.TİP KLV.ÇEK.BAŞ. | 48 | 136 | 78 | 17,5 | 17,5 |
| 378214                       | BT 50 M2 / M14 EM.TİP KLV.ÇEK.BAŞ.  | 19 | 82  | 38 | 7    | 7    |
| 378524                       | BT 50 M5 / M24 EM.TİP KLV.ÇEK.BAŞ.  | 31 | 102 | 54 | 12   | 12   |
| 3781436                      | BT 50 M14 / M36 EM.TİP KLV.ÇEK.BAŞ. | 48 | 142 | 78 | 17,5 | 17,5 |



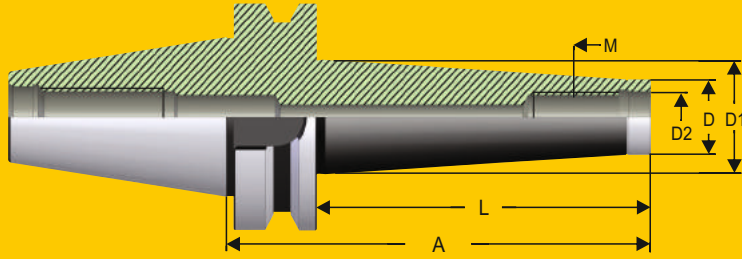

Sayfa / Page :  
G-14,16,17



Sayfa : G-10  
Page : G-10



Sayfa : G-11  
Page : G-11

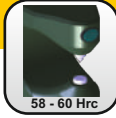

58 - 60 Hrc



V N5

STANDART  
BALANS  
G 2,5  
20000 min<sup>-1</sup>



| SİPARİŞ KODU<br>Order Number | ÜRÜN ADI<br>Product Name  | M   | D  | D1 | A   | L   | D2   |
|------------------------------|---------------------------|-----|----|----|-----|-----|------|
| 384008                       | BT 40 VİDALI TAKIM TUTUCU | M8  | 13 | 23 | 77  | 50  | 8,5  |
| 384008.1                     | BT 40 VİDALI TAKIM TUTUCU | M8  | 13 | 25 | 127 | 100 | 8,5  |
| 384008.2                     | BT 40 VİDALI TAKIM TUTUCU | M8  | 13 | 30 | 177 | 150 | 8,5  |
| 384010                       | BT 40 VİDALI TAKIM TUTUCU | M10 | 18 | 23 | 77  | 50  | 10,5 |
| 384010.1                     | BT 40 VİDALI TAKIM TUTUCU | M10 | 18 | 32 | 127 | 100 | 10,5 |
| 384010.2                     | BT 40 VİDALI TAKIM TUTUCU | M10 | 18 | 36 | 177 | 150 | 10,5 |
| 384012                       | BT 40 VİDALI TAKIM TUTUCU | M12 | 21 | 25 | 77  | 50  | 12,5 |
| 384012.1                     | BT 40 VİDALI TAKIM TUTUCU | M12 | 21 | 32 | 127 | 100 | 12,5 |
| 384012.2                     | BT 40 VİDALI TAKIM TUTUCU | M12 | 21 | 40 | 177 | 150 | 12,5 |
| 384016                       | BT 40 VİDALI TAKIM TUTUCU | M16 | 29 | 34 | 102 | 75  | 17   |
| 384016.1                     | BT 40 VİDALI TAKIM TUTUCU | M16 | 29 | 40 | 152 | 125 | 17   |

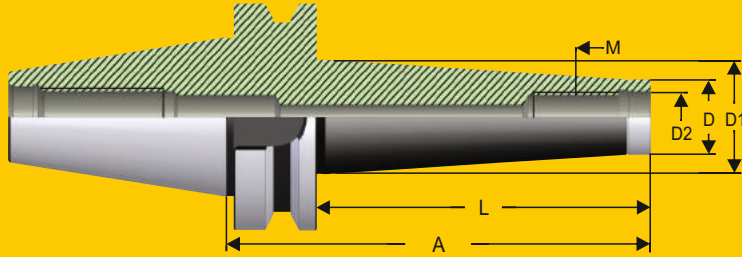

Sayfa / Page :  
G-14,16,17



Sayfa : G-10  
Page : G-10



Sayfa : G-11  
Page : G-11

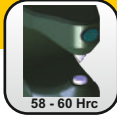

58 - 60 Hrc



V N5



| SİPARİŞ KODU<br>Order Number | ÜRÜN ADI<br>Product Name  | M   | D  | D1 | A   | L   | D2   |
|------------------------------|---------------------------|-----|----|----|-----|-----|------|
| 385008                       | BT 50 VİDALI TAKIM TUTUCU | M8  | 13 | 25 | 138 | 100 | 8,5  |
| 385008.1                     | BT 50 VİDALI TAKIM TUTUCU | M8  | 13 | 30 | 188 | 150 | 8,5  |
| 385010                       | BT 50 VİDALI TAKIM TUTUCU | M10 | 18 | 32 | 138 | 100 | 10,5 |
| 385010.1                     | BT 50 VİDALI TAKIM TUTUCU | M10 | 18 | 36 | 188 | 150 | 10,5 |
| 385012                       | BT 50 VİDALI TAKIM TUTUCU | M12 | 21 | 33 | 138 | 100 | 12,5 |
| 385012.1                     | BT 50 VİDALI TAKIM TUTUCU | M12 | 21 | 40 | 188 | 150 | 12,5 |
| 385016                       | BT 50 VİDALI TAKIM TUTUCU | M16 | 29 | 36 | 138 | 100 | 17   |
| 385016.1                     | BT 50 VİDALI TAKIM TUTUCU | M16 | 29 | 42 | 188 | 150 | 17   |

**JIS B 6339 ( MAS 403 BT )**  
ÖZEL TAKIM YAPMAK İÇİN YUMUŞAK BARA  
Boring bar blanks for producing special tools



**DEĞERLİ®**  
www.degerlimakina.com

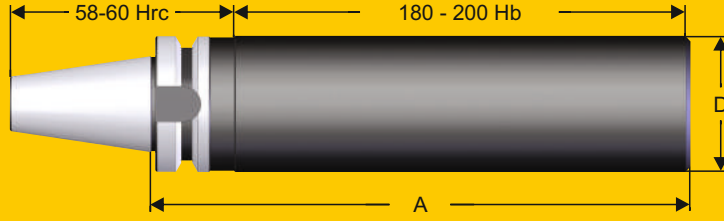

Sayfa / Page :  
G-14,16,17



Sayfa : G-10  
Page : G-10



Sayfa : G-11  
Page : G-11

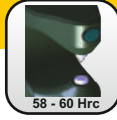

58 - 60 Hrc



V N5



| SİPARİŞ KODU<br>Order Number | ÜRÜN ADI<br>Product Name  | D  | A   |
|------------------------------|---------------------------|----|-----|
| 394000                       | BT 40 ÖZEL TAKIM HAM BARA | 63 | 250 |
| 395000                       | BT 50 ÖZEL TAKIM HAM BARA | 97 | 315 |

**JIS B 6339 ( MAS 403 BT )**  
AHŞAP KUTULU PENS TAKIMI DIN 6388-B  
Collet set in wooden box DIN 6388 form B



**DEĞERLİ®**  
www.degerlimakina.com



Sayfa : G-10  
Page : G-10



Sayfa : G-11  
Page : G-11

| SİPARİŞ KODU<br>Order Number | ÜRÜN ADI<br>Product Name | KAPASİTE<br>Capacity | PENS ADEDİ<br>Collet Piece |
|------------------------------|--------------------------|----------------------|----------------------------|
| 393415                       | BT 30 / 415 PENS TAKIMI  | 3.....16 mm          | 12                         |
| 393462                       | BT 30 / 462 PENS TAKIMI  | 4.....25 mm          | 16                         |
| 394415                       | BT 40 / 415 PENS TAKIMI  | 3.....16 mm          | 12                         |
| 394462                       | BT 40 / 462 PENS TAKIMI  | 4.....25 mm          | 16                         |
| 394467                       | BT 40 / 467 PENS TAKIMI  | 5.....32 mm          | 16                         |
| 395462                       | BT 50 / 462 PENS TAKIMI  | 4.....25 mm          | 16                         |
| 395467                       | BT 50 / 467 PENS TAKIMI  | 5.....32 mm          | 16                         |
| 395468                       | BT 50 / 468 PENS TAKIMI  | 6.....40 mm          | 20                         |

**JIS B 6339 ( MAS 403 BT )**  
AHŞAP KUTULU PENS TAKIMI DIN 6499 ER  
Collet set in wooden box DIN 6499 ER



**DEĞERLİ®**  
www.degerlimakina.com



Sayfa : G-10  
Page : G-10



Sayfa : G-11  
Page : G-11

| SİPARİŞ KODU<br>Order Number | ÜRÜN ADI<br>Product Name      | KAPASİTE<br>Capacity | PENS ADEDİ<br>Collet Piece |
|------------------------------|-------------------------------|----------------------|----------------------------|
| 393430                       | BT 30 ER 25 / 430 PENS TAKIMI | 3.....16 mm          | 14                         |
| 393470                       | BT 30 ER 32 / 470 PENS TAKIMI | 3.....20 mm          | 14                         |
| 393472                       | BT 30 ER 40 / 472 PENS TAKIMI | 4.....26 mm          | 16                         |
| 394430                       | BT 40 ER 25 / 430 PENS TAKIMI | 3.....16 mm          | 14                         |
| 394470                       | BT 40 ER 32 / 470 PENS TAKIMI | 3.....20 mm          | 14                         |
| 394472                       | BT 40 ER 40 / 472 PENS TAKIMI | 4.....26 mm          | 16                         |
| 395430                       | BT 50 ER 25 / 430 PENS TAKIMI | 3.....16 mm          | 14                         |
| 395470                       | BT 50 ER 32 / 470 PENS TAKIMI | 3.....20 mm          | 14                         |
| 395472                       | BT 50 ER 40 / 472 PENS TAKIMI | 4.....26 mm          | 16                         |



**JIS B 6339 ( MAS 403 BT )**  
AHŞAP KUTULU RULMANLI PENS TAKIMI  
Collet set in wooden box



**DEĞERLİ®**  
www.degerlimakina.com



Sayfa : G-10  
Page : G-10



Sayfa : G-11  
Page : G-11

| SİPARİŞ KODU<br>Order Number | ÜRÜN ADI<br>Product Name   | KAPASİTE<br>Capacity<br>( d ) | PENS ADEDİ<br>Collet Piece |
|------------------------------|----------------------------|-------------------------------|----------------------------|
| 398420                       | BT 40 RULMANLI PENS TAKIMI | 6.....20                      | 5                          |
| 398432                       | BT 40 RULMANLI PENS TAKIMI | 6.....32                      | 7                          |
| 399520                       | BT 50 RULMANLI PENS TAKIMI | 6.....20                      | 5                          |
| 399532                       | BT 50 RULMANLI PENS TAKIMI | 6.....32                      | 7                          |



**silindirik şaftlı tutucular**  
**cylindrical shaft toolholders**



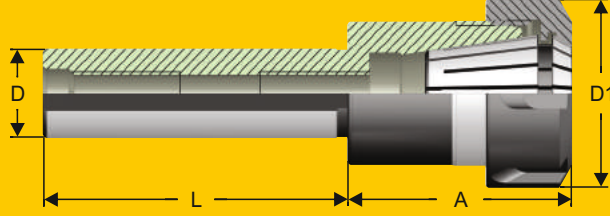

Sayfa / Page :  
A-01,02,03,04



Sayfa : G-02  
Page : G-02



Sayfa : G-02  
Page : G-02



Sayfa : G-13  
Page : G-13



Sayfa : G-13  
Page : G-13



Sayfa : G-13  
Page : G-13

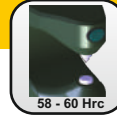

58 - 60 Hrc



V N6

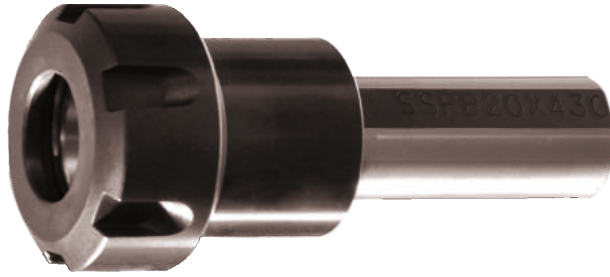

| SİPARİŞ KODU<br>Order Number | ÜRÜN ADI<br>Product Name           | KAPASİTE<br>Capacity | D  | L   | A  | D1 |
|------------------------------|------------------------------------|----------------------|----|-----|----|----|
| 4 20 426                     | SİL.ŞAFTLI ER 16 / 426 PENS TUTUCU | 2.....10 mm          | 20 | 70  | 30 | 32 |
| 4 20 426.1                   | SİL.ŞAFTLI ER 16 / 426 PENS TUTUCU | 2.....10 mm          | 20 | 100 | 30 | 32 |
| 4 20 426.2                   | SİL.ŞAFTLI ER 16 / 426 PENS TUTUCU | 2.....10 mm          | 20 | 100 | 30 | 22 |
| 4 20 426.3                   | SİL.ŞAFTLI ER 16 / 426 PENS TUTUCU | 2.....10 mm          | 20 | 150 | 30 | 22 |
| 4 20 426.4                   | SİL.ŞAFTLI ER 16 / 426 PENS TUTUCU | 2.....10 mm          | 20 | 150 | 30 | 32 |
| 4 20 426.5                   | SİL.ŞAFTLI ER 16 / 426 PENS TUTUCU | 2.....10 mm          | 20 | 200 | 30 | 22 |
| ★ 4 20 428                   | SİL.ŞAFTLI ER 20 / 428 PENS TUTUCU | 2.....12 mm          | 20 | 70  | 45 | 34 |
| ★ 4 20 428.1                 | SİL.ŞAFTLI ER 20 / 428 PENS TUTUCU | 2.....12 mm          | 20 | 70  | 45 | 34 |
| ★ 4 20 428.2                 | SİL.ŞAFTLI ER 20 / 428 PENS TUTUCU | 2.....12 mm          | 20 | 150 | 45 | 34 |
| 4 20 430                     | SİL.ŞAFTLI ER 25 / 430 PENS TUTUCU | 2.....16 mm          | 20 | 70  | 52 | 42 |
| 4 20 430.1                   | SİL.ŞAFTLI ER 25 / 430 PENS TUTUCU | 2.....16 mm          | 20 | 150 | 52 | 42 |
| 4 20 470                     | SİL.ŞAFTLI ER 32 / 470 PENS TUTUCU | 2.....20 mm          | 20 | 70  | 55 | 50 |
| 4 20 470.1                   | SİL.ŞAFTLI ER 32 / 470 PENS TUTUCU | 2.....20 mm          | 20 | 150 | 55 | 50 |

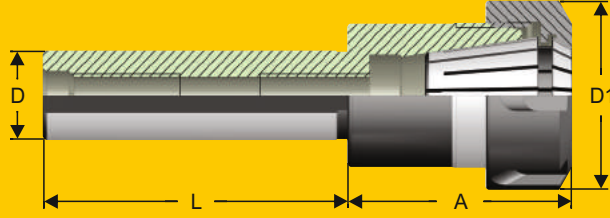

Sayfa / Page :  
A-01,02,03,04



Sayfa : G-02  
Page : G-02



Sayfa : G-02  
Page : G-02



Sayfa : G-13  
Page : G-13



Sayfa : G-13  
Page : G-13



Sayfa : G-13  
Page : G-13

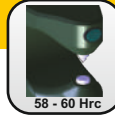

58 - 60 Hrc



V N6



| SİPARİŞ KODU<br>Order Number | ÜRÜN ADI<br>Product Name           | KAPASİTE<br>Capacity | D  | L   | A  | D1 |
|------------------------------|------------------------------------|----------------------|----|-----|----|----|
| 4 25 426                     | SİL.ŞAFTLI ER 16 / 426 PENS TUTUCU | 2.....10 mm          | 25 | 70  | 32 | 32 |
| 4 25 426.1                   | SİL.ŞAFTLI ER 16 / 426 PENS TUTUCU | 2.....10 mm          | 25 | 150 | 32 | 32 |
| ★ 4 25 428                   | SİL.ŞAFTLI ER 20 / 428 PENS TUTUCU | 2.....12 mm          | 25 | 70  | 35 | 34 |
| ★ 4 25 428.1                 | SİL.ŞAFTLI ER 20 / 428 PENS TUTUCU | 2.....12 mm          | 25 | 150 | 35 | 34 |
| 4 25 430                     | SİL.ŞAFTLI ER 25 / 430 PENS TUTUCU | 2.....16 mm          | 25 | 70  | 50 | 42 |
| 4 25 430.1                   | SİL.ŞAFTLI ER 25 / 430 PENS TUTUCU | 2.....16 mm          | 25 | 150 | 50 | 42 |
| 4 25 470                     | SİL.ŞAFTLI ER 32 / 470 PENS TUTUCU | 2.....20 mm          | 25 | 70  | 55 | 50 |
| 4 25 470.1                   | SİL.ŞAFTLI ER 32 / 470 PENS TUTUCU | 2.....20 mm          | 25 | 150 | 55 | 50 |



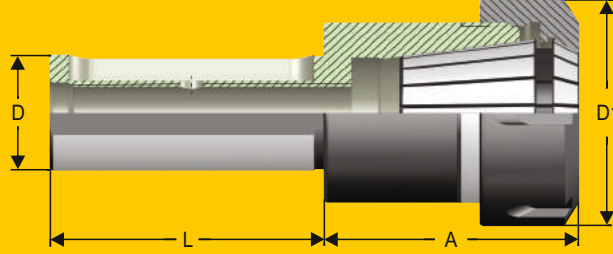

Sayfa / Page :  
A-01,03,04,05



Sayfa : G-02  
Page : G-02



Sayfa : G-13  
Page : G-13

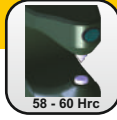

58 - 60 Hrc



V N5



| SİPARİŞ KODU<br>Order Number | ÜRÜN ADI<br>Product Name           | KAPASİTE<br>Capacity | D  | L   | A  | D1 |
|------------------------------|------------------------------------|----------------------|----|-----|----|----|
| 4 32 426                     | SİL.ŞAFTLI ER 16 / 426 PENS TUTUCU | 2.....10 mm          | 32 | 80  | 32 | 32 |
| 4 32 430                     | SİL.ŞAFTLI ER 25 / 430 PENS TUTUCU | 2.....16 mm          | 32 | 80  | 32 | 42 |
| 4 32 430.1                   | SİL.ŞAFTLI ER 25 / 430 PENS TUTUCU | 2.....16 mm          | 32 | 150 | 32 | 42 |
| 4 32 470                     | SİL.ŞAFTLI ER 32 / 470 PENS TUTUCU | 2.....20 mm          | 32 | 80  | 52 | 50 |
| 4 32 470.1                   | SİL.ŞAFTLI ER 32 / 470 PENS TUTUCU | 2.....20 mm          | 32 | 150 | 52 | 50 |
| 4 32 472                     | SİL.ŞAFTLI ER 40 / 472 PENS TUTUCU | 2.....26 mm          | 32 | 80  | 63 | 63 |
| 4 32 472.1                   | SİL.ŞAFTLI ER 40 / 472 PENS TUTUCU | 2.....26 mm          | 32 | 150 | 63 | 63 |



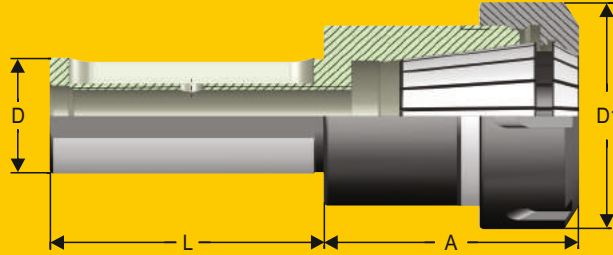

Sayfa / Page :  
A-01,03,04,05



Sayfa : G-02  
Page : G-02



Sayfa : G-13  
Page : G-13

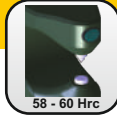

58 - 60 Hrc



VN5



| SİPARİŞ KODU<br>Order Number | ÜRÜN ADI<br>Product Name           | KAPASİTE<br>Capacity | D  | L   | A  | D1 |
|------------------------------|------------------------------------|----------------------|----|-----|----|----|
| 4 40 430                     | SİL.ŞAFTLI ER 25 / 430 PENS TUTUCU | 2.....16 mm          | 40 | 85  | 32 | 42 |
| 4 40 430.1                   | SİL.ŞAFTLI ER 25 / 430 PENS TUTUCU | 2.....16 mm          | 40 | 150 | 32 | 42 |
| 4 40 470                     | SİL.ŞAFTLI ER 32 / 470 PENS TUTUCU | 2.....20 mm          | 40 | 85  | 35 | 50 |
| 4 40 470.1                   | SİL.ŞAFTLI ER 32 / 470 PENS TUTUCU | 2.....20 mm          | 40 | 150 | 35 | 50 |
| 4 40 472                     | SİL.ŞAFTLI ER 40 / 472 PENS TUTUCU | 2.....26 mm          | 40 | 85  | 45 | 63 |
| 4 40 472.1                   | SİL.ŞAFTLI ER 40 / 472 PENS TUTUCU | 2.....26 mm          | 40 | 150 | 45 | 63 |

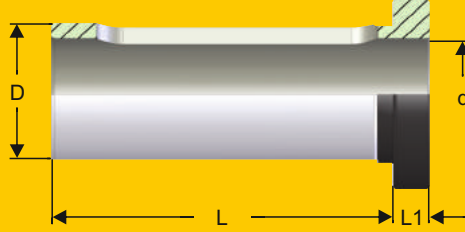

| SİPARİŞ KODU<br>Order Number | ÜRÜN ADI<br>Product Name            | d  | D  | L  | L1 |
|------------------------------|-------------------------------------|----|----|----|----|
| 4 20 06                      | SİLİNDİRİK ŞAFTLI REDÜKSİYON KOVANI | 6  | 20 | 40 | 5  |
| 4 20 08                      | SİLİNDİRİK ŞAFTLI REDÜKSİYON KOVANI | 8  | 20 | 40 | 5  |
| 4 20 10                      | SİLİNDİRİK ŞAFTLI REDÜKSİYON KOVANI | 10 | 20 | 40 | 5  |
| 4 20 12                      | SİLİNDİRİK ŞAFTLI REDÜKSİYON KOVANI | 12 | 20 | 40 | 5  |
| 4 20 16                      | SİLİNDİRİK ŞAFTLI REDÜKSİYON KOVANI | 16 | 20 | 40 | 5  |

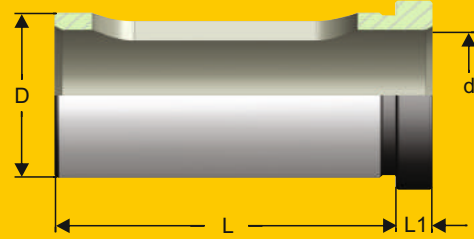
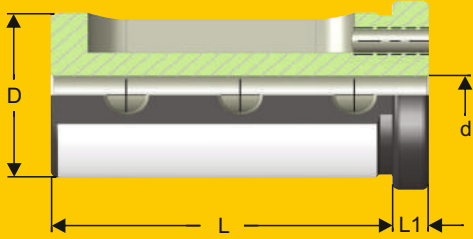

| SİPARİŞ KODU<br>Order Number | ÜRÜN ADI<br>Product Name            | d  | D  | L  | L1 |
|------------------------------|-------------------------------------|----|----|----|----|
| 4 25 06                      | SİLİNDİRİK ŞAFTLI REDÜKSİYON KOVANI | 6  | 25 | 45 | 5  |
| 4 25 08                      | SİLİNDİRİK ŞAFTLI REDÜKSİYON KOVANI | 8  | 25 | 45 | 5  |
| 4 25 10                      | SİLİNDİRİK ŞAFTLI REDÜKSİYON KOVANI | 10 | 25 | 45 | 5  |
| 4 25 12                      | SİLİNDİRİK ŞAFTLI REDÜKSİYON KOVANI | 12 | 25 | 45 | 5  |
| 4 25 16                      | SİLİNDİRİK ŞAFTLI REDÜKSİYON KOVANI | 16 | 25 | 45 | 5  |
| 4 25 20                      | SİLİNDİRİK ŞAFTLI REDÜKSİYON KOVANI | 20 | 25 | 45 | 5  |

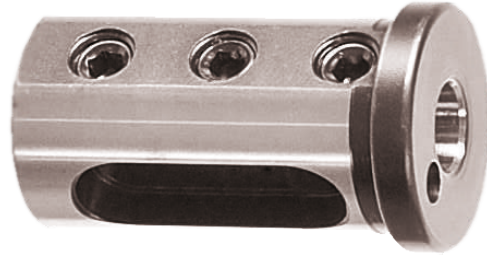
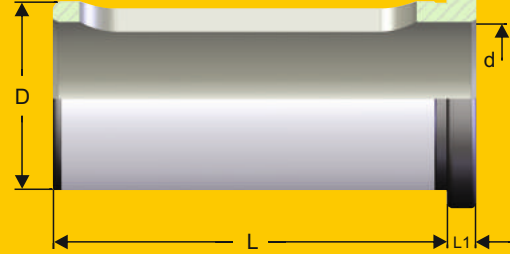
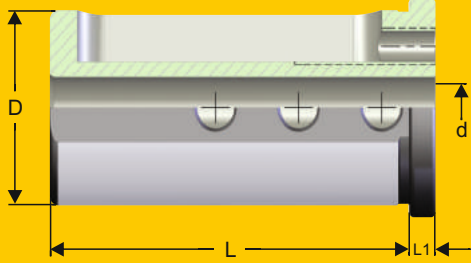

| SİPARİŞ KODU<br>Order Number | ÜRÜN ADI<br>Product Name            | d  | D  | L  | L1 |
|------------------------------|-------------------------------------|----|----|----|----|
| 4 32 06                      | SİLİNDİRİK ŞAFTLI REDÜKSİYON KOVANI | 6  | 32 | 65 | 5  |
| 4 32 08                      | SİLİNDİRİK ŞAFTLI REDÜKSİYON KOVANI | 8  | 32 | 65 | 5  |
| 4 32 10                      | SİLİNDİRİK ŞAFTLI REDÜKSİYON KOVANI | 10 | 32 | 65 | 5  |
| 4 32 12                      | SİLİNDİRİK ŞAFTLI REDÜKSİYON KOVANI | 12 | 32 | 65 | 5  |
| 4 32 16                      | SİLİNDİRİK ŞAFTLI REDÜKSİYON KOVANI | 16 | 32 | 65 | 5  |
| 4 32 20                      | SİLİNDİRİK ŞAFTLI REDÜKSİYON KOVANI | 20 | 32 | 65 | 5  |
| 4 32 25                      | SİLİNDİRİK ŞAFTLI REDÜKSİYON KOVANI | 25 | 32 | 65 | 5  |

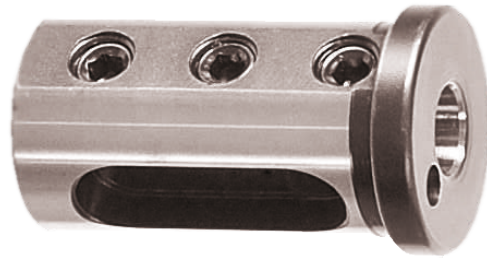
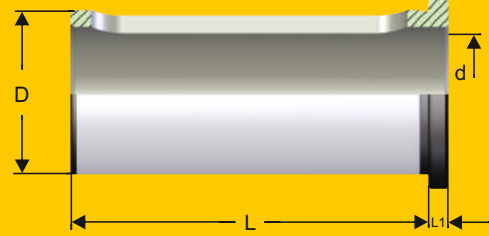
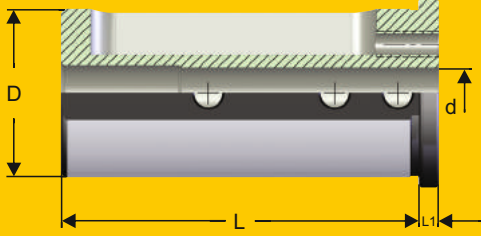

| SİPARİŞ KODU<br>Order Number | ÜRÜN ADI<br>Product Name            | d  | D  | L  | L1 |
|------------------------------|-------------------------------------|----|----|----|----|
| 4 40 08                      | SİLİNDİRİK ŞAFTLI REDÜKSİYON KOVANI | 8  | 40 | 75 | 5  |
| 4 40 10                      | SİLİNDİRİK ŞAFTLI REDÜKSİYON KOVANI | 10 | 40 | 75 | 5  |
| 4 40 12                      | SİLİNDİRİK ŞAFTLI REDÜKSİYON KOVANI | 12 | 40 | 75 | 5  |
| 4 40 16                      | SİLİNDİRİK ŞAFTLI REDÜKSİYON KOVANI | 16 | 40 | 75 | 5  |
| 4 40 20                      | SİLİNDİRİK ŞAFTLI REDÜKSİYON KOVANI | 20 | 40 | 75 | 5  |
| 4 40 25                      | SİLİNDİRİK ŞAFTLI REDÜKSİYON KOVANI | 25 | 40 | 75 | 5  |
| 4 40 32                      | SİLİNDİRİK ŞAFTLI REDÜKSİYON KOVANI | 32 | 40 | 75 | 5  |



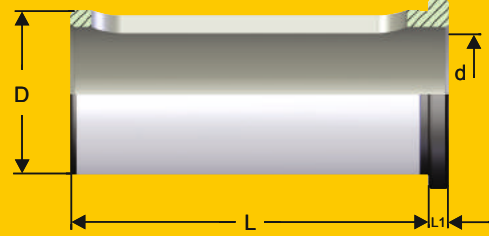
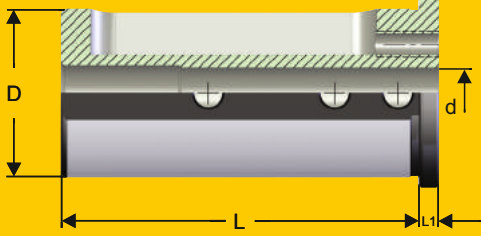

| SİPARİŞ KODU<br>Order Number | ÜRÜN ADI<br>Product Name            | d  | D  | L  | L1 |
|------------------------------|-------------------------------------|----|----|----|----|
| 4 50 08                      | SİLİNDİRİK ŞAFTLI REDÜKSİYON KOVANI | 8  | 50 | 90 | 5  |
| 4 50 10                      | SİLİNDİRİK ŞAFTLI REDÜKSİYON KOVANI | 10 | 50 | 90 | 5  |
| 4 50 12                      | SİLİNDİRİK ŞAFTLI REDÜKSİYON KOVANI | 12 | 50 | 90 | 5  |
| 4 50 16                      | SİLİNDİRİK ŞAFTLI REDÜKSİYON KOVANI | 16 | 50 | 90 | 5  |
| 4 50 20                      | SİLİNDİRİK ŞAFTLI REDÜKSİYON KOVANI | 20 | 50 | 90 | 5  |
| 4 50 25                      | SİLİNDİRİK ŞAFTLI REDÜKSİYON KOVANI | 25 | 50 | 90 | 5  |
| 4 50 32                      | SİLİNDİRİK ŞAFTLI REDÜKSİYON KOVANI | 32 | 50 | 90 | 5  |
| 4 50 40                      | SİLİNDİRİK ŞAFTLI REDÜKSİYON KOVANI | 40 | 50 | 90 | 5  |

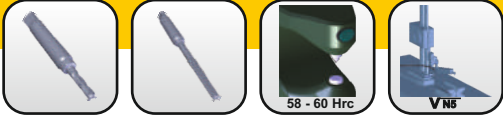
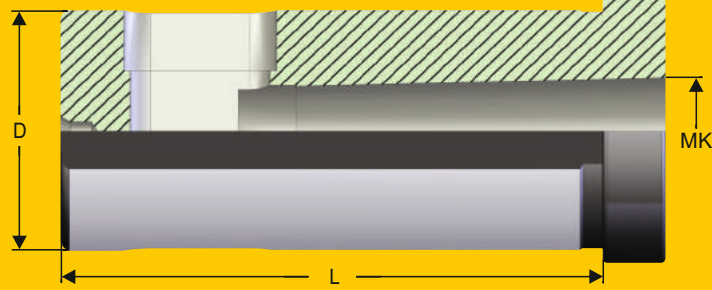

| SİPARİŞ KODU<br>Order Number | ÜRÜN ADI<br>Product Name        | MK<br>Morse | D  | L  |
|------------------------------|---------------------------------|-------------|----|----|
| 4 32 01                      | SİLİNDİRİK ŞAFTLI MORS ADAPTÖRÜ | 1           | 32 | 75 |
| 4 32 02                      | SİLİNDİRİK ŞAFTLI MORS ADAPTÖRÜ | 2           | 32 | 80 |
| 4 32 03                      | SİLİNDİRİK ŞAFTLI MORS ADAPTÖRÜ | 3           | 32 | 80 |
| 4 40 01                      | SİLİNDİRİK ŞAFTLI MORS ADAPTÖRÜ | 1           | 40 | 75 |
| 4 40 02                      | SİLİNDİRİK ŞAFTLI MORS ADAPTÖRÜ | 2           | 40 | 85 |
| 4 40 03                      | SİLİNDİRİK ŞAFTLI MORS ADAPTÖRÜ | 3           | 40 | 85 |
| 4 40 04                      | SİLİNDİRİK ŞAFTLI MORS ADAPTÖRÜ | 4           | 40 | 85 |
| 4 50 01                      | SİLİNDİRİK ŞAFTLI MORS ADAPTÖRÜ | 1           | 50 | 75 |
| 4 50 02                      | SİLİNDİRİK ŞAFTLI MORS ADAPTÖRÜ | 2           | 50 | 88 |
| 4 50 03                      | SİLİNDİRİK ŞAFTLI MORS ADAPTÖRÜ | 3           | 50 | 90 |
| 4 50 04                      | SİLİNDİRİK ŞAFTLI MORS ADAPTÖRÜ | 4           | 50 | 90 |

SİLİNDİRİK ŞAFTLI GİRİŞ - ÇIKIŞ KOMPANZİYELİ  
PENS TUTUCULU KLAVUZ ÇEKME BAŞLIĞI DIN 6499 ER  
Cylindrical shank with compensation and collet chuck  
tapping length DIN 6499 ER



**DEĞERLİ®**

www.degerlimakina.com

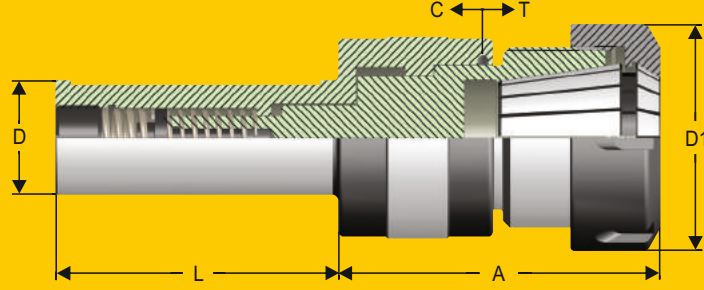

Sayfa / Page :  
A-01,04,05



Sayfa : G-02  
Page : G-02



Sayfa : G-13  
Page : G-13

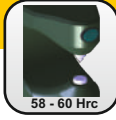

58 - 60 Hrc



V N5



| SİPARİŞ KODU<br>Order Number | ÜRÜN ADI<br>Product Name         | KAPASİTE<br>Capacity | D  | L  | A  | D1 | C | T |
|------------------------------|----------------------------------|----------------------|----|----|----|----|---|---|
| 48 20 426                    | S.ŞAFTLI KLAVUZ ÇEKME ER 16 P.B. | 2.....10 mm          | 20 | 80 | 42 | 32 | 8 | 3 |
| 48 25 426                    | S.ŞAFTLI KLAVUZ ÇEKME ER 16 P.B. | 2.....10 mm          | 25 | 80 | 42 | 32 | 8 | 3 |
| 48 32 470                    | S.ŞAFTLI KLAVUZ ÇEKME ER 32 P.B. | 2.....20 mm          | 32 | 80 | 77 | 50 | 9 | 4 |
| 48 32 472                    | S.ŞAFTLI KLAVUZ ÇEKME ER 40 P.B. | 2.....26 mm          | 32 | 80 | 96 | 63 | 9 | 4 |

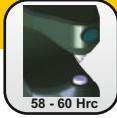
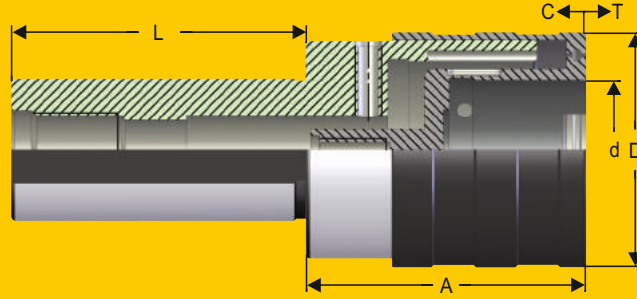

Sayfa / Page :  
G-05,06,07



| SİPARİŞ KODU<br>Order Number | ÜRÜN ADI<br>Product Name          | KAPASİTE<br>Capacity | A  | D  | d  | C  | T  | L  |
|------------------------------|-----------------------------------|----------------------|----|----|----|----|----|----|
| 48 25 214                    | SİL.ŞAFTLI EM.TİP KLAVUZ ÇEKME B. | M2.....M14           | 45 | 38 | 19 | 7  | 7  | 70 |
| 48 25 524                    | SİL.ŞAFTLI EM.TİP KLAVUZ ÇEKME B. | M5.....M24           | 71 | 54 | 31 | 12 | 12 | 70 |
| 48 32 214                    | SİL.ŞAFTLI EM.TİP KLAVUZ ÇEKME B. | M2.....M14           | 45 | 38 | 19 | 7  | 7  | 80 |
| 48 32 524                    | SİL.ŞAFTLI EM.TİP KLAVUZ ÇEKME B. | M5.....M24           | 71 | 54 | 31 | 12 | 12 | 80 |
| 48 40 214                    | SİL.ŞAFTLI EM.TİP KLAVUZ ÇEKME B. | M2.....M14           | 45 | 38 | 19 | 7  | 7  | 85 |
| 48 40 524                    | SİL.ŞAFTLI EM.TİP KLAVUZ ÇEKME B. | M5.....M24           | 71 | 54 | 31 | 12 | 12 | 85 |



| SİPARİŞ KODU<br>Order Number | ÜRÜN ADI<br>Product Name           | D x L     | KAPASİTE<br>Capacity | PENS ADEDİ<br>Collet Piece |
|------------------------------|------------------------------------|-----------|----------------------|----------------------------|
| 49 20 430                    | SİL.ŞAFTLI ER 25 / 430 PENS TAKIMI | Ø 20 x 70 | 3.....16 mm          | 14                         |
| 49 20 470                    | SİL.ŞAFTLI ER 32 / 470 PENS TAKIMI | Ø 20 x 70 | 3.....20 mm          | 14                         |
| 49 25 430                    | SİL.ŞAFTLI ER 25 / 430 PENS TAKIMI | Ø 25 x 70 | 3.....16 mm          | 14                         |
| 49 25 470                    | SİL.ŞAFTLI ER 32 / 470 PENS TAKIMI | Ø 25 x 70 | 3.....20 mm          | 14                         |
| 49 32 430                    | SİL.ŞAFTLI ER 25 / 430 PENS TAKIMI | Ø 32 x 80 | 3.....16 mm          | 14                         |
| 49 32 470                    | SİL.ŞAFTLI ER 32 / 470 PENS TAKIMI | Ø 32 x 80 | 3.....20 mm          | 14                         |
| 49 32 472                    | SİL.ŞAFTLI ER 40 / 472 PENS TAKIMI | Ø 32 x 80 | 4.....26 mm          | 16                         |
| 49 40 430                    | SİL.ŞAFTLI ER 25 / 430 PENS TAKIMI | Ø 40 x 85 | 3.....16 mm          | 14                         |
| 49 40 470                    | SİL.ŞAFTLI ER 32 / 470 PENS TAKIMI | Ø 40 x 85 | 3.....20 mm          | 14                         |
| 49 40 472                    | SİL.ŞAFTLI ER 40 / 472 PENS TAKIMI | Ø 40 x 85 | 4.....26 mm          | 16                         |





**DIN 69871 AD**  
**sk başlıklar**  
**sk toolholders**



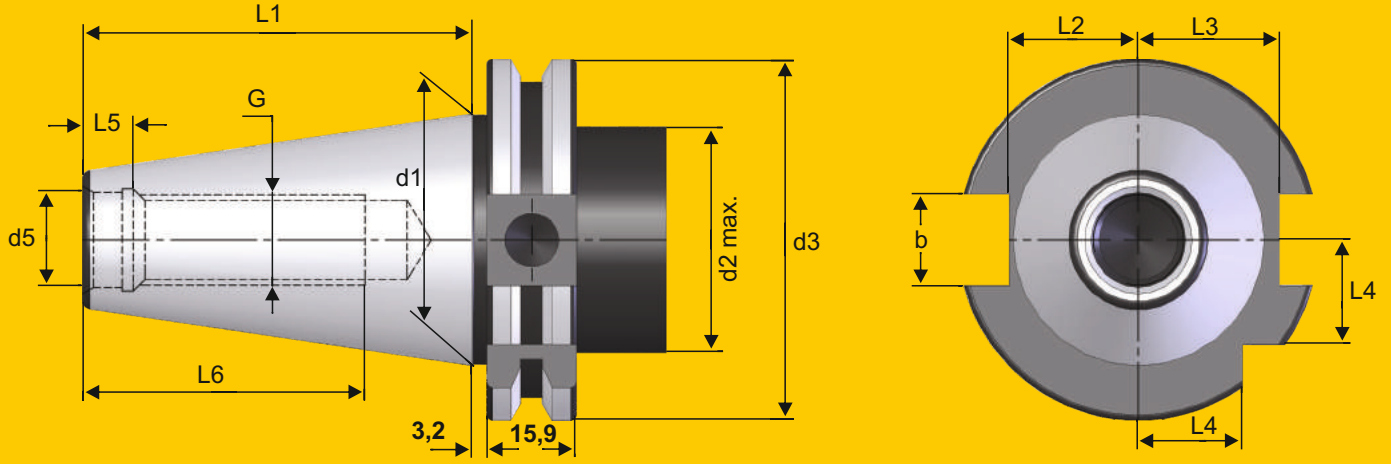

STANDART  
BALANS  
G 6,3  
12000 min<sup>-1</sup>



| ÜRÜN ADI<br>Product Name  | d1    | G   | d5 | d2 | d3    | L1     | L2   | L3   | L4   | L5   | L6 | b    |
|---|-------|-----|----|----|-------|--------|------|------|------|------|----|------|
|  SK 30 | 31,75 | M12 | 13 | 45 | 50,00 | 47,80  | 16,4 | 19,0 | 15   | 5,5  | 24 | 16,1 |
| SK 40   | 44,45 | M16 | 17 | 50 | 63,55 | 68,40  | 22,8 | 25,0 | 18,5 | 8,2  | 32 | 16,1 |
| SK 50   | 69,85 | M24 | 25 | 80 | 97,50 | 101,75 | 35,5 | 37,7 | 30   | 11,5 | 47 | 25,7 |

# DIN 69871 AD

PENS BAŞLIĞI DIN 6391 PENS 6388

Collet chucks DIN 6391 for Collets DIN 6388



# DEĞERLİ®

www.degerlimakina.com

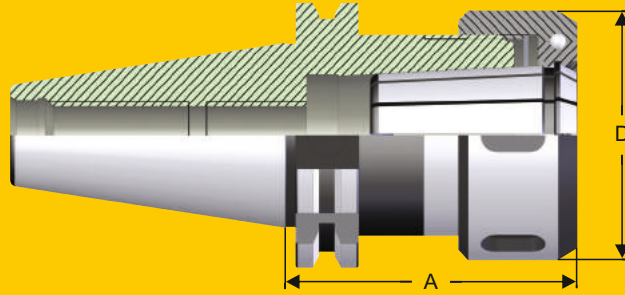

Safa : G-15  
Page : G-15



Sayfa : G-01  
Page : G-01



Sayfa / Page :  
A-07,09,10



Sayfa : G-12  
Page : G-12



Sayfa : E-26  
Page : E-26



Sayfa : G-10  
Page : G-10



Sayfa : G-11  
Page : G-11

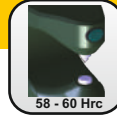

58 - 60 Hrc



VN5



| SİPARİŞ KODU<br>Order Number | ÜRÜN ADI<br>Product Name | KAPASİTE<br>Capacity | D  | A  |
|------------------------------|--------------------------|----------------------|----|----|
| ★ 510415                     | SK 30 415 PENS BAŞLIĞI   | 2.....16 mm          | 43 | 60 |
| ★ 510462                     | SK 30 462 PENS BAŞLIĞI   | 2.....25 mm          | 60 | 80 |
| 511415                       | SK 40 415 PENS BAŞLIĞI   | 2.....16 mm          | 43 | 70 |
| 511462                       | SK 40 462 PENS BAŞLIĞI   | 2.....25 mm          | 60 | 70 |
| 511467                       | SK 40 467 PENS BAŞLIĞI   | 3.....32 mm          | 72 | 90 |
| 515462                       | SK 50 462 PENS BAŞLIĞI   | 2.....25 mm          | 60 | 70 |
| 515467                       | SK 50 467 PENS BAŞLIĞI   | 3.....32 mm          | 72 | 80 |

# DIN 69871 AD

PENS BAŞLIĞI DIN 6499 ER

Collet chucks for Collets DIN 6499 ER



# DEĞERLİ®

www.degerlimakina.com

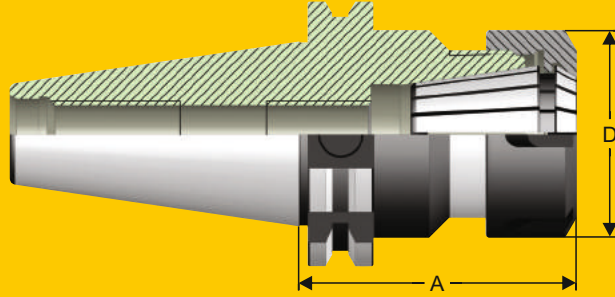

Sayfa : G-15  
Page : G-15



Sayfa : G-02  
Page : G-02



Sayfa / Page :  
A-01,03,04,05



Sayfa : G-13  
Page : G-13



Sayfa : E-27  
Page : E-27



Sayfa : G-10  
Page : G-10



Sayfa : G-11  
Page : G-11

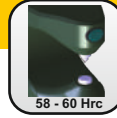

58 - 60 Hrc



VN5

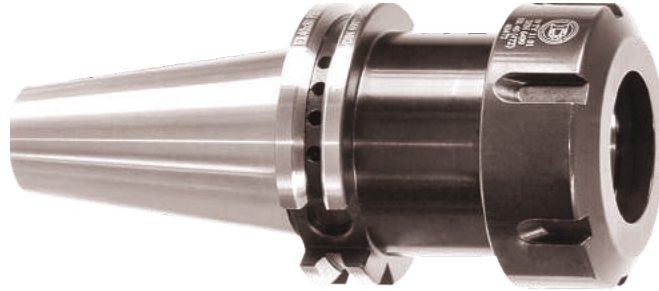

| SİPARİŞ KODU<br>Order Number | ÜRÜN ADI<br>Product Name       | KAPASİTE<br>Capacity | D  | A  |
|------------------------------|--------------------------------|----------------------|----|----|
| 510426                       | SK 30 ER 16 / 426 PENS BAŞLIĞI | 2.....10 mm          | 32 | 70 |
| 510430                       | SK 30 ER 25 / 430 PENS BAŞLIĞI | 2.....16 mm          | 42 | 70 |
| 510470                       | SK 30 ER 32 / 470 PENS BAŞLIĞI | 2.....20 mm          | 50 | 70 |
| 510472                       | SK 30 ER 40 / 472 PENS BAŞLIĞI | 2.....26 mm          | 63 | 70 |
| 511426                       | SK 40 ER 16 / 426 PENS BAŞLIĞI | 2.....10 mm          | 32 | 63 |
| 511430                       | SK 40 ER 25 / 430 PENS BAŞLIĞI | 2.....16 mm          | 42 | 60 |
| 511470                       | SK 40 ER 32 / 470 PENS BAŞLIĞI | 2.....20 mm          | 50 | 70 |
| 511472                       | SK 40 ER 40 / 472 PENS BAŞLIĞI | 2.....26 mm          | 63 | 80 |
| 515426                       | SK 50 ER 16 / 426 PENS BAŞLIĞI | 2.....10 mm          | 32 | 63 |
| 515430                       | SK 50 ER 25 / 430 PENS BAŞLIĞI | 2.....16 mm          | 42 | 60 |
| 515470                       | SK 50 ER 32 / 470 PENS BAŞLIĞI | 2.....20 mm          | 50 | 70 |
| 515472                       | SK 50 ER 40 / 472 PENS BAŞLIĞI | 2.....26 mm          | 63 | 80 |



# DIN 69871 AD

PENS BAŞLIĞI DIN 6499 ER

Collet chucks for Collets DIN 6499 ER



# DEĞERLİ®

www.degerlimakina.com

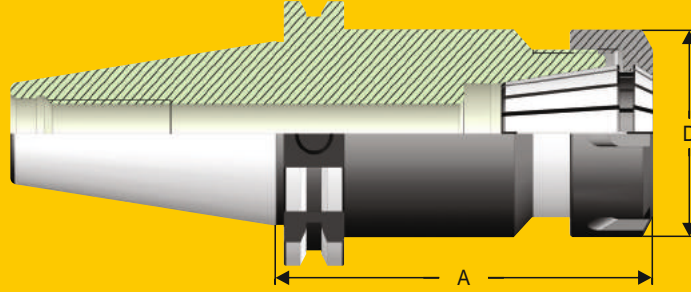

Sayfa : G-15  
Page : G-15



Sayfa : G-02  
Page : G-02



Sayfa : G-02  
Page : G-02



Sayfa / Page :  
A-01,03,04,05



Sayfa : G-13  
Page : G-13



Sayfa : G-13  
Page : G-13



Sayfa : E-27  
Page : E-27



Sayfa : G-10  
Page : G-10



Sayfa : G-11  
Page : G-11

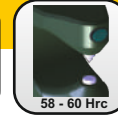

58 - 60 Hrc



V N6



| SİPARİŞ KODU<br>Order Number | ÜRÜN ADI<br>Product Name       | KAPASİTE<br>Capacity | D  | A   |
|------------------------------|--------------------------------|----------------------|----|-----|
| 510426.1                     | SK 30 ER 16 / 426 PENS BAŞLIĞI | 2.....10 mm          | 32 | 100 |
| 510430.1                     | SK 30 ER 25 / 430 PENS BAŞLIĞI | 2.....16 mm          | 42 | 100 |
| 510470.1                     | SK 30 ER 32 / 470 PENS BAŞLIĞI | 2.....20 mm          | 50 | 100 |
| 512426.1                     | SK 40 ER 16 / 426 PENS BAŞLIĞI | 2.....10 mm          | 22 | 100 |
| 512426                       | SK 40 ER 16 / 426 PENS BAŞLIĞI | 2.....10 mm          | 32 | 100 |
| 512430                       | SK 40 ER 25 / 430 PENS BAŞLIĞI | 2.....16 mm          | 42 | 100 |
| 512470                       | SK 40 ER 32 / 470 PENS BAŞLIĞI | 2.....20 mm          | 50 | 100 |
| 512472                       | SK 40 ER 40 / 472 PENS BAŞLIĞI | 2.....26 mm          | 63 | 100 |
| 516426                       | SK 50 ER 16 / 426 PENS BAŞLIĞI | 2.....10 mm          | 32 | 100 |
| 516426.1                     | SK 50 ER 16 / 426 PENS BAŞLIĞI | 2.....10 mm          | 22 | 100 |
| 516430                       | SK 50 ER 25 / 430 PENS BAŞLIĞI | 2.....16 mm          | 42 | 100 |
| 516470                       | SK 50 ER 32 / 470 PENS BAŞLIĞI | 2.....20 mm          | 50 | 100 |
| 516472                       | SK 50 ER 40 / 472 PENS BAŞLIĞI | 2.....26 mm          | 63 | 100 |



# DIN 69871 AD

PENS BAŞLIĞI DIN 6499 ER

Collet chucks for Collets DIN 6499 ER



# DEĞERLİ®

www.degerlimakina.com

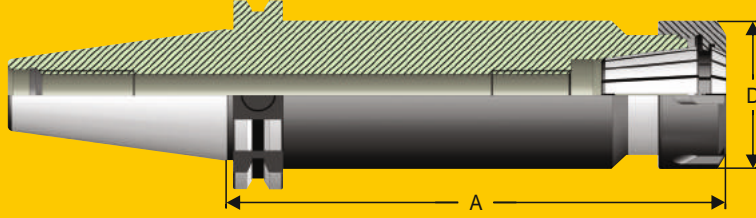

Sayfa : G-15  
Page : G-15



Sayfa : G-02  
Page : G-02



Sayfa : G-02  
Page : G-02



Sayfa / Page :  
A-01,03,04,05



Sayfa : G-13  
Page : G-13



Sayfa : G-13  
Page : G-13



Sayfa : E-27  
Page : E-27



Sayfa : G-10  
Page : G-10



Sayfa : G-11  
Page : G-11

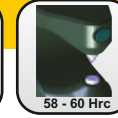

58 - 60 Hrc



V N6



| SİPARİŞ KODU<br>Order Number | ÜRÜN ADI<br>Product Name       | KAPASİTE<br>Capacity | D  | A   |
|------------------------------|--------------------------------|----------------------|----|-----|
| 513426.1                     | SK 40 ER 16 / 426 PENS BAŞLIĞI | 2.....10 mm          | 22 | 160 |
| 513426                       | SK 40 ER 16 / 426 PENS BAŞLIĞI | 2.....10 mm          | 32 | 160 |
| 513430                       | SK 40 ER 25 / 430 PENS BAŞLIĞI | 2.....16 mm          | 42 | 160 |
| 513470                       | SK 40 ER 32 / 470 PENS BAŞLIĞI | 2.....20 mm          | 50 | 160 |
| 513472                       | SK 40 ER 40 / 472 PENS BAŞLIĞI | 2.....26 mm          | 63 | 160 |
| 517426.1                     | SK 50 ER 16 / 426 PENS BAŞLIĞI | 2.....10 mm          | 22 | 160 |
| 517430                       | SK 50 ER 25 / 430 PENS BAŞLIĞI | 2.....16 mm          | 42 | 160 |
| 517470                       | SK 50 ER 32 / 470 PENS BAŞLIĞI | 2.....20 mm          | 50 | 160 |
| 517472                       | SK 50 ER 40 / 472 PENS BAŞLIĞI | 2.....26 mm          | 63 | 160 |

## DIN 69871 AD

HASSAS AYARLANABİLİR PENS BAŞLIĞI DIN 6499  
Adjustable tool holder DIN 6499



# DEĞERLİ®

www.degerlimakina.com

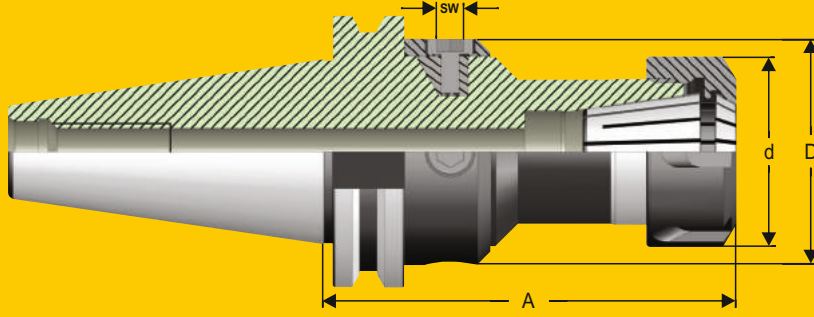

Sayfa : G-15  
Page : G-15



Sayfa : G-02  
Page : G-02



Sayfa / Page :  
A-03,04,05



Sayfa : G-13  
Page : G-13



Sayfa : E-27  
Page : E-27



Sayfa : G-10  
Page : G-10



Sayfa : G-11  
Page : G-11

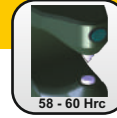

58 - 60 Hrc



VN5



| SİPARİŞ KODU<br>Order Number | ÜRÜN ADI<br>Product Name                 | KAPASİTE<br>Capacity | d  | A   | D  | SW |
|------------------------------|--|----------------------|----|-----|----|----|
| 514430                       | SK 40 ER 25 / 430 HAS.AYAR. PENS BAŞLIĞI | 2.....16 mm          | 42 | 85  | 50 | 5  |
| 514470                       | SK 40 ER 32 / 470 HAS.AYAR. PENS BAŞLIĞI | 2.....20 mm          | 50 | 90  | 50 | 5  |
| 514472                       | SK 40 ER 40 / 472 HAS.AYAR. PENS BAŞLIĞI | 2.....26 mm          | 63 | 115 | 60 | 5  |
| 518470                       | SK 50 ER 32 / 470 HAS.AYAR. PENS BAŞLIĞI | 2.....20 mm          | 50 | 90  | 50 | 5  |
| 518472                       | SK 50 ER 40 / 472 HAS.AYAR. PENS BAŞLIĞI | 2.....26 mm          | 63 | 100 | 60 | 5  |

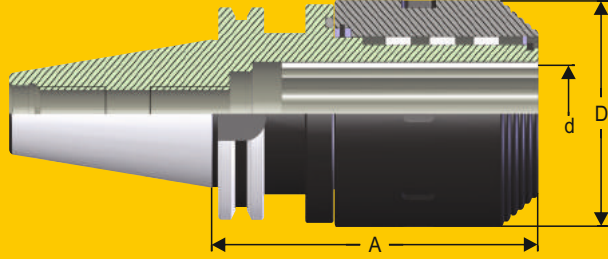

Sayfa : G-15  
Page : G-15



Sayfa : G-01  
Page : G-01



Sayfa : A-12,13  
Page : A-12,13



Sayfa : E-28  
Page : E-28



Sayfa : G-10  
Page : G-10



Sayfa : G-11  
Page : G-11

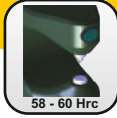

58 - 60 Hrc



VN6

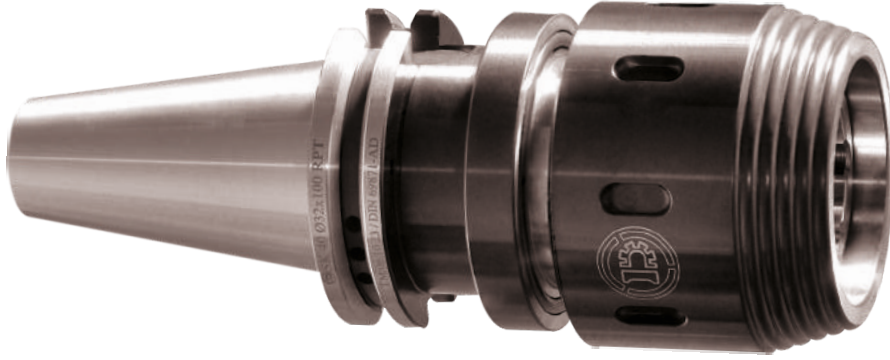

| SİPARİŞ KODU<br>Order Number | ÜRÜN ADI<br>Product Name   | KAPASİTE<br>Capacity<br>( d ) | A   | D  |
|------------------------------|----------------------------|-------------------------------|-----|----|
| 518420                       | SK 40 RULMANLI PENS TUTUCU | 6.....20 mm                   | 90  | 49 |
| 518432                       | SK 40 RULMANLI PENS TUTUCU | 6.....32 mm                   | 100 | 68 |
| 519520                       | SK 50 RULMANLI PENS TUTUCU | 6.....20 mm                   | 70  | 49 |
| 519532                       | SK 50 RULMANLI PENS TUTUCU | 6.....32 mm                   | 95  | 68 |

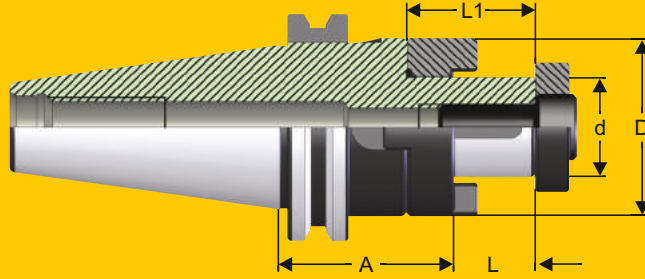

Sayfa : G-15  
Page : G-15



Sayfa : G-08  
Page : G-08



Sayfa : G-09  
Page : G-09



Sayfa : G-10  
Page : G-10



Sayfa : G-11  
Page : G-11

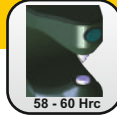

58 - 60 Hrc



VN5



| SİPARİŞ KODU<br>Order Number | ÜRÜN ADI<br>Product Name | d<br>h6 | D  | A  | L  | L1 |
|------------------------------|--------------------------|---------|----|----|----|----|
| 523016                       | SK 30 / K.T.B. 16        | 16      | 32 | 50 | 17 | 27 |
| 523022                       | SK 30 / K.T.B. 22        | 22      | 40 | 50 | 19 | 31 |
| 523027                       | SK 30 / K.T.B. 27        | 27      | 48 | 55 | 21 | 33 |
| 523032                       | SK 30 / K.T.B. 32        | 32      | 58 | 60 | 24 | 38 |
| 524016                       | SK 40 / K.T.B. 16        | 16      | 32 | 55 | 17 | 27 |
| 524022                       | SK 40 / K.T.B. 22        | 22      | 40 | 55 | 19 | 31 |
| 524027                       | SK 40 / K.T.B. 27        | 27      | 48 | 55 | 21 | 33 |
| 524032                       | SK 40 / K.T.B. 32        | 32      | 58 | 60 | 24 | 38 |
| 524040                       | SK 40 / K.T.B. 40        | 40      | 70 | 60 | 27 | 41 |
| 525016                       | SK 50 / K.T.B. 16        | 16      | 32 | 55 | 17 | 27 |
| 525022                       | SK 50 / K.T.B. 22        | 22      | 40 | 55 | 19 | 31 |
| 525027                       | SK 50 / K.T.B. 27        | 27      | 48 | 55 | 21 | 33 |
| 525032                       | SK 50 / K.T.B. 32        | 32      | 58 | 55 | 24 | 38 |
| 525040                       | SK 50 / K.T.B. 40        | 40      | 70 | 55 | 27 | 41 |

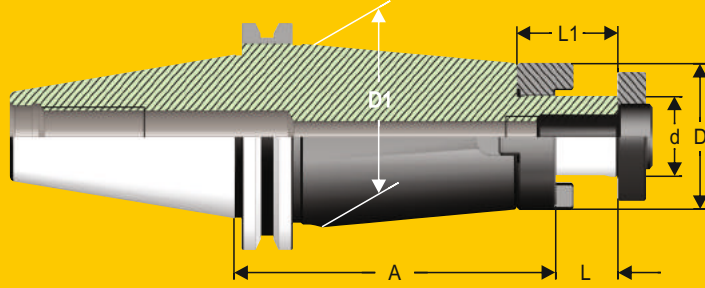

Sayfa : G-15  
Page : G-15



Sayfa : G-08  
Page : G-08



Sayfa : G-09  
Page : G-09



Sayfa : G-10  
Page : G-10



Sayfa : G-11  
Page : G-11

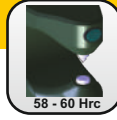

58 - 60 Hrc



VN5



| SİPARİŞ KODU<br>Order Number | ÜRÜN ADI<br>Product Name | d<br>h6 | D  | A   | L  | L1 | D1 |
|------------------------------|--------------------------|---------|----|-----|----|----|----|
| 524116                       | SK 40 / K.T.B. 16        | 16      | 32 | 100 | 17 | 27 | 38 |
| 524122                       | SK 40 / K.T.B. 22        | 22      | 40 | 100 | 19 | 31 | 48 |
| 524127                       | SK 40 / K.T.B. 27        | 27      | 48 | 100 | 21 | 33 | 50 |
| 524132                       | SK 40 / K.T.B. 32        | 32      | 58 | 100 | 24 | 38 | 58 |
| 524140                       | SK 40 / K.T.B. 40        | 40      | 70 | 100 | 27 | 41 | 70 |
| 525116                       | SK 50 / K.T.B. 16        | 16      | 32 | 100 | 17 | 27 | 38 |
| 525122                       | SK 50 / K.T.B. 22        | 22      | 40 | 100 | 19 | 31 | 48 |
| 525127                       | SK 50 / K.T.B. 27        | 27      | 48 | 100 | 21 | 33 | 58 |
| 525132                       | SK 50 / K.T.B. 32        | 32      | 58 | 100 | 24 | 38 | 68 |
| 525140                       | SK 50 / K.T.B. 40        | 40      | 70 | 100 | 27 | 41 | 80 |



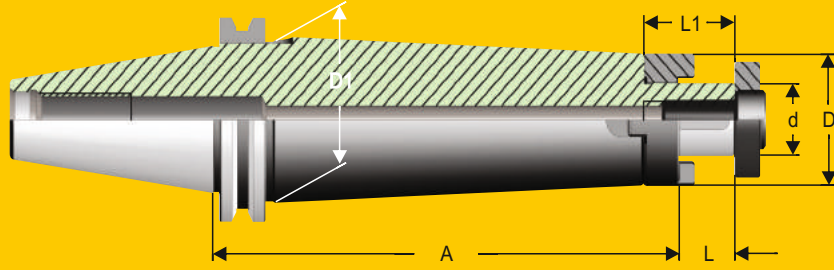

Sayfa : G-15  
Page : G-15



Sayfa : G-08  
Page : G-08



Sayfa : G-09  
Page : G-09



Sayfa : G-10  
Page : G-10



Sayfa : G-11  
Page : G-11

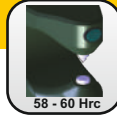

| SİPARİŞ KODU<br>Order Number | ÜRÜN ADI<br>Product Name | d<br>h6 | D  | A   | L  | L1 | D1 |
|------------------------------|--------------------------|---------|----|-----|----|----|----|
| 524116.1                     | SK 40 / K.T.B. 16        | 16      | 32 | 160 | 17 | 27 | 38 |
| 524122.1                     | SK 40 / K.T.B. 22        | 22      | 40 | 160 | 19 | 31 | 48 |
| 524127.1                     | SK 40 / K.T.B. 27        | 27      | 48 | 160 | 21 | 33 | 50 |
| 524132.1                     | SK 40 / K.T.B. 32        | 32      | 58 | 160 | 24 | 38 | 58 |
| 524140.1                     | SK 40 / K.T.B. 40        | 40      | 70 | 160 | 27 | 41 | 70 |
| 525116.1                     | SK 50 / K.T.B. 16        | 16      | 32 | 160 | 17 | 27 | 38 |
| 525122.1                     | SK 50 / K.T.B. 22        | 22      | 40 | 160 | 19 | 31 | 48 |
| 525127.1                     | SK 50 / K.T.B. 27        | 27      | 48 | 160 | 21 | 33 | 58 |
| 525132.1                     | SK 50 / K.T.B. 32        | 32      | 58 | 160 | 24 | 38 | 68 |
| 525140.1                     | SK 50 / K.T.B. 40        | 40      | 70 | 160 | 27 | 41 | 80 |

# DIN 69871 AD

ALIN KAMALI MALAFA DIN 6357  
Shell mill holder DIN 6357  
for cutters with driving slot



# DEĞERLİ®

www.degerlimakina.com

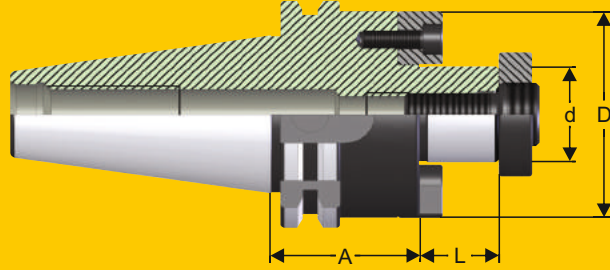

Sayfa : G-15  
Page : G-15



Sayfa : G-08  
Page : G-08



Sayfa : G-10  
Page : G-10



Sayfa : G-11  
Page : G-11



58 - 60 Hrc



VN5



| SİPARİŞ KODU<br>Order Number | ÜRÜN ADI<br>Product Name | d  | D   | A  | L  |
|------------------------------|--------------------------|----|-----|----|----|
| 533016                       | SK 30 / A.T.B. 16        | 16 | 38  | 40 | 17 |
| 533022                       | SK 30 / A.T.B. 22        | 22 | 48  | 40 | 19 |
| 533027                       | SK 30 / A.T.B. 27        | 27 | 58  | 50 | 21 |
| 533032                       | SK 30 / A.T.B. 32        | 32 | 78  | 50 | 24 |
| 534016                       | SK 40 / A.T.B. 16        | 16 | 38  | 35 | 17 |
| 534022                       | SK 40 / A.T.B. 22        | 22 | 48  | 35 | 19 |
| 534027                       | SK 40 / A.T.B. 27        | 27 | 58  | 40 | 21 |
| 534032                       | SK 40 / A.T.B. 32        | 32 | 78  | 50 | 24 |
| 534040                       | SK 40 / A.T.B. 40        | 40 | 88  | 50 | 27 |
| 535016                       | SK 50 / A.T.B. 16        | 16 | 38  | 35 | 17 |
| 535022                       | SK 50 / A.T.B. 22        | 22 | 48  | 35 | 19 |
| 535027                       | SK 50 / A.T.B. 27        | 27 | 58  | 40 | 21 |
| 535032                       | SK 50 / A.T.B. 32        | 32 | 78  | 50 | 24 |
| 535040                       | SK 50 / A.T.B. 40        | 40 | 88  | 50 | 27 |
| 535060                       | SK 50 / A.T.B. 60        | 60 | 128 | 70 | 40 |

## DIN 69871 AD

WELDON TUTUCU DIN 6359  
SİLİNDİRİK ŞAFTLI DIN 1835-B

End mill holder DIN 6359  
for weldon type end mills DIN 1835-B



# DEĞERLİ®

www.degerlimakina.com

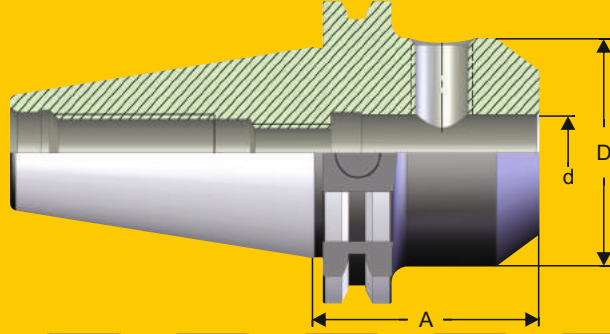

Sayfa : G-15  
Page : G-15



Sayfa : G-20  
Page : G-20



Sayfa : G-10  
Page : G-10



Sayfa : G-11  
Page : G-11

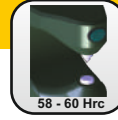

| SİPARİŞ KODU<br>Order Number | ÜRÜN ADI<br>Product Name | d<br>H4 | D  | A  |
|------------------------------|--------------------------|---------|----|----|
| 543006                       | SK 30 WELDON             | 6       | 25 | 50 |
| 543008                       | SK 30 WELDON             | 8       | 28 | 50 |
| 543010                       | SK 30 WELDON             | 10      | 35 | 50 |
| 543012                       | SK 30 WELDON             | 12      | 42 | 50 |
| 543014                       | SK 30 WELDON             | 14      | 44 | 63 |
| 543016                       | SK 30 WELDON             | 16      | 48 | 63 |
| 543018                       | SK 30 WELDON             | 18      | 50 | 63 |
| 543020                       | SK 30 WELDON             | 20      | 52 | 70 |

# DIN 69871 AD

WELDON TUTUCU DIN 6359  
SİLİNDİRİK ŞAFTLI DIN 1835-B

End mill holder DIN 6359  
for weldon type end mills DIN 1835-B



# DEĞERLİ®

www.degerlimakina.com

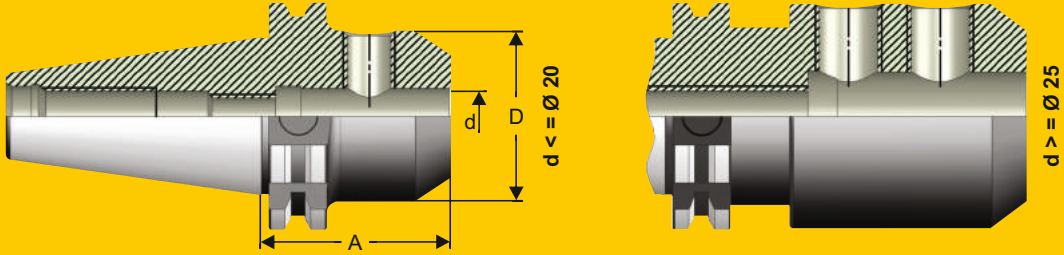

Sayfa : G-15  
Page : G-15



Sayfa : G-20  
Page : G-20



Sayfa : G-10  
Page : G-10



Sayfa : G-11  
Page : G-11

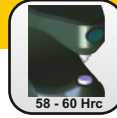

58 - 60 Hrc



VN5



| SİPARİŞ KODU<br>Order Number | ÜRÜN ADI<br>Product Name | d<br>H4 | D  | A   |
|------------------------------|--------------------------|---------|----|-----|
| 544006                       | SK 40 WELDON             | 6       | 25 | 50  |
| 544008                       | SK 40 WELDON             | 8       | 28 | 50  |
| 544010                       | SK 40 WELDON             | 10      | 35 | 50  |
| 544012                       | SK 40 WELDON             | 12      | 42 | 50  |
| 544014                       | SK 40 WELDON             | 14      | 44 | 50  |
| 544016                       | SK 40 WELDON             | 16      | 48 | 63  |
| 544018                       | SK 40 WELDON             | 18      | 50 | 63  |
| 544020                       | SK 40 WELDON             | 20      | 52 | 63  |
| 544025                       | SK 40 WELDON             | 25      | 63 | 100 |
| 544032                       | SK 40 WELDON             | 32      | 72 | 100 |
| 544040                       | SK 40 WELDON             | 40      | 79 | 120 |

## DIN 69871 AD

WELDON TUTUCU DIN 6359  
SİLİNDİRİK ŞAFTLI DIN 1835-B

End mill holder DIN 6359  
for weldon type end mills DIN 1835-B



# DEĞERLİ®

www.degerlimakina.com

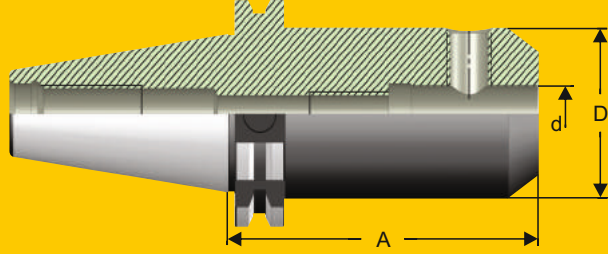

Sayfa : G-15  
Page : G-15



Sayfa : G-20  
Page : G-20



Sayfa : G-10  
Page : G-10



Sayfa : G-11  
Page : G-11

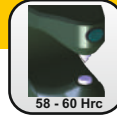

| SİPARİŞ KODU<br>Order Number | ÜRÜN ADI<br>Product Name | d<br>H4 | D  | A   |
|------------------------------|--------------------------|---------|----|-----|
| 544106                       | SK 40 WELDON             | 6       | 25 | 100 |
| 544108                       | SK 40 WELDON             | 8       | 28 | 100 |
| 544110                       | SK 40 WELDON             | 10      | 35 | 100 |
| 544112                       | SK 40 WELDON             | 12      | 42 | 100 |
| 544114                       | SK 40 WELDON             | 14      | 44 | 100 |
| 544116                       | SK 40 WELDON             | 16      | 48 | 100 |
| 544118                       | SK 40 WELDON             | 18      | 50 | 100 |
| 544120                       | SK 40 WELDON             | 20      | 52 | 100 |



# DIN 69871 AD

WELDON TUTUCU DIN 6359  
SİLİNDİRİK ŞAFTLI DIN 1835-B

End mill holder DIN 6359  
for weldon type end mills DIN 1835-B



# DEĞERLİ®

www.degerlimakina.com

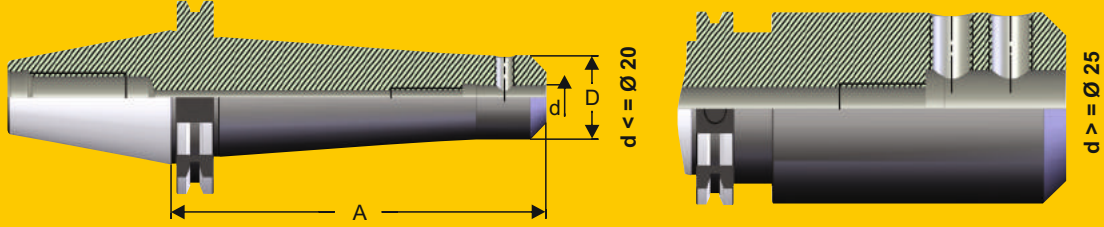

Sayfa : G-15  
Page : G-15



Sayfa : G-20  
Page : G-20



Sayfa : G-10  
Page : G-10



Sayfa : G-11  
Page : G-11

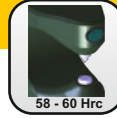

| SİPARİŞ KODU<br>Order Number | ÜRÜN ADI<br>Product Name | d<br>H4 | D  | A   |
|------------------------------|--------------------------|---------|----|-----|
| 544106.1                     | SK 40 WELDON             | 6       | 25 | 160 |
| 544108.1                     | SK 40 WELDON             | 8       | 28 | 160 |
| 544110.1                     | SK 40 WELDON             | 10      | 35 | 160 |
| 544112.1                     | SK 40 WELDON             | 12      | 42 | 160 |
| 544114.1                     | SK 40 WELDON             | 14      | 44 | 160 |
| 544116.1                     | SK 40 WELDON             | 16      | 48 | 160 |
| 544118.1                     | SK 40 WELDON             | 18      | 50 | 160 |
| 544120.1                     | SK 40 WELDON             | 20      | 52 | 160 |
| 544125.1                     | SK 40 WELDON             | 25      | 63 | 160 |
| 544132.1                     | SK 40 WELDON             | 32      | 72 | 160 |

# DIN 69871 AD

WELDON TUTUCU DIN 6359  
SİLİNDİRİK ŞAFTLI DIN 1835-B

End mill holder DIN 6359  
for weldon type end mills DIN 1835-B



# DEĞERLİ®

www.degerlimakina.com

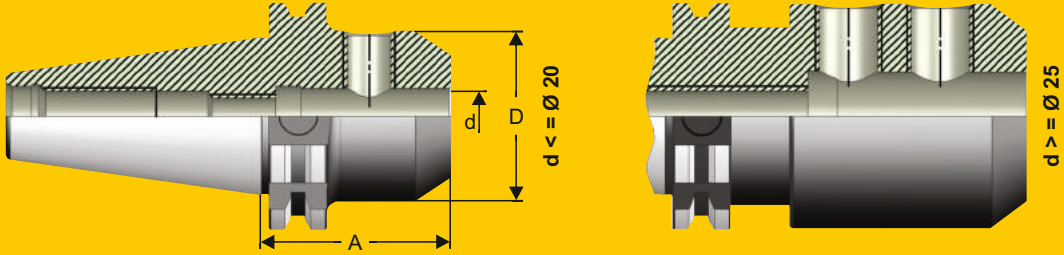

Sayfa : G-15  
Page : G-15



Sayfa : G-20  
Page : G-20



Sayfa : G-10  
Page : G-10



Sayfa : G-11  
Page : G-11

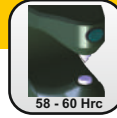

| SİPARİŞ KODU<br>Order Number | ÜRÜN ADI<br>Product Name | d<br>H4 | D  | A   |
|------------------------------|--------------------------|---------|----|-----|
| 545006                       | SK 50 WELDON             | 6       | 25 | 63  |
| 545008                       | SK 50 WELDON             | 8       | 28 | 63  |
| 545010                       | SK 50 WELDON             | 10      | 35 | 63  |
| 545012                       | SK 50 WELDON             | 12      | 42 | 63  |
| 545014                       | SK 50 WELDON             | 14      | 44 | 63  |
| 545016                       | SK 50 WELDON             | 16      | 48 | 63  |
| 545018                       | SK 50 WELDON             | 18      | 50 | 63  |
| 545020                       | SK 50 WELDON             | 20      | 52 | 63  |
| 545025                       | SK 50 WELDON             | 25      | 65 | 80  |
| 545032                       | SK 50 WELDON             | 32      | 72 | 100 |
| 545040                       | SK 50 WELDON             | 40      | 80 | 100 |

# DIN 69871 AD

WELDON TUTUCU DIN 6359  
SİLİNDİRİK ŞAFTLI DIN 1835-B

End mill holder DIN 6359  
for weldon type end mills DIN 1835-B



# DEĞERLİ®

www.degerlimakina.com

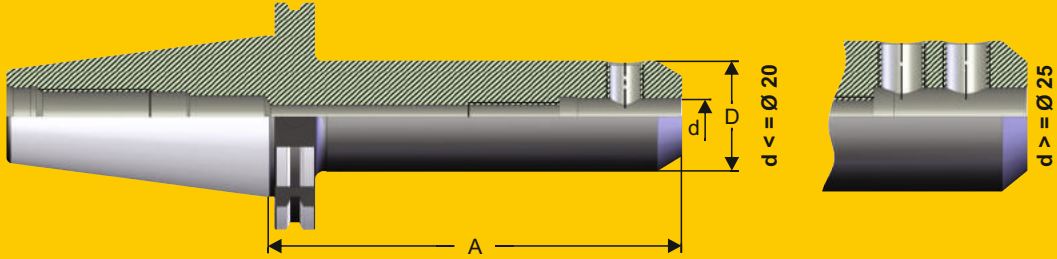

Sayfa : G-15  
Page : G-15



Sayfa : G-20  
Page : G-20



Sayfa : G-10  
Page : G-10



Sayfa : G-11  
Page : G-11

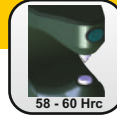

58 - 60 Hrc



VN5



| SİPARİŞ KODU<br>Order Number | ÜRÜN ADI<br>Product Name | d<br>H4 | D  | A   |
|------------------------------|--------------------------|---------|----|-----|
| 545106                       | SK 50 WELDON             | 6       | 25 | 160 |
| 545108                       | SK 50 WELDON             | 8       | 28 | 160 |
| 545110                       | SK 50 WELDON             | 10      | 35 | 160 |
| 545112                       | SK 50 WELDON             | 12      | 42 | 160 |
| 545114                       | SK 50 WELDON             | 14      | 44 | 160 |
| 545116                       | SK 50 WELDON             | 16      | 48 | 160 |
| 545118                       | SK 50 WELDON             | 18      | 50 | 160 |
| 545120                       | SK 50 WELDON             | 20      | 52 | 160 |
| 545125                       | SK 50 WELDON             | 25      | 65 | 160 |
| 545132                       | SK 50 WELDON             | 32      | 72 | 160 |
| 545140                       | SK 50 WELDON             | 40      | 80 | 160 |

## DIN 69871 AD

KAMALI MORS ADAPTÖRÜ DIN 6383  
Morse taper adaptor tang DIN 6383



# DEĞERLİ®

www.degerlimakina.com

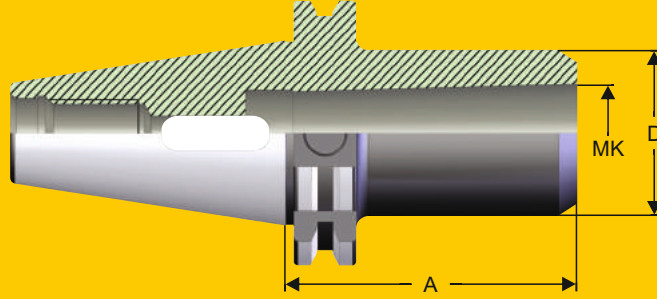

Sayfa : G-15  
Page : G-15



Sayfa : G-10  
Page : G-10



Sayfa : G-11  
Page : G-11

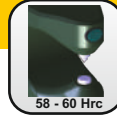

58 - 60 Hrc



V N5



| SİPARİŞ KODU<br>Order Number | ÜRÜN ADI<br>Product Name   | MK<br>Morse | D  | A   |
|------------------------------|----------------------------|-------------|----|-----|
| 553001                       | SK 30 KAMALI MORS ADAPTÖRÜ | 1           | 25 | 50  |
| 553002                       | SK 30 KAMALI MORS ADAPTÖRÜ | 2           | 32 | 65  |
| 553003                       | SK 30 KAMALI MORS ADAPTÖRÜ | 3           | 40 | 80  |
| 554001                       | SK 40 KAMALI MORS ADAPTÖRÜ | 1           | 25 | 50  |
| 554002                       | SK 40 KAMALI MORS ADAPTÖRÜ | 2           | 32 | 50  |
| 554003                       | SK 40 KAMALI MORS ADAPTÖRÜ | 3           | 40 | 70  |
| 554004                       | SK 40 KAMALI MORS ADAPTÖRÜ | 4           | 48 | 95  |
| 555001                       | SK 50 KAMALI MORS ADAPTÖRÜ | 1           | 25 | 45  |
| 555002                       | SK 50 KAMALI MORS ADAPTÖRÜ | 2           | 32 | 60  |
| 555003                       | SK 50 KAMALI MORS ADAPTÖRÜ | 3           | 40 | 65  |
| 555004                       | SK 50 KAMALI MORS ADAPTÖRÜ | 4           | 48 | 95  |
| 555005                       | SK 50 KAMALI MORS ADAPTÖRÜ | 5           | 63 | 105 |

## DIN 69871 AD

ÇEKTİRMELİ MORS ADAPTÖRÜ DIN 6364  
Morse taper adaptor drawbar DIN 6364



# DEĞERLİ®

www.degerlimakina.com

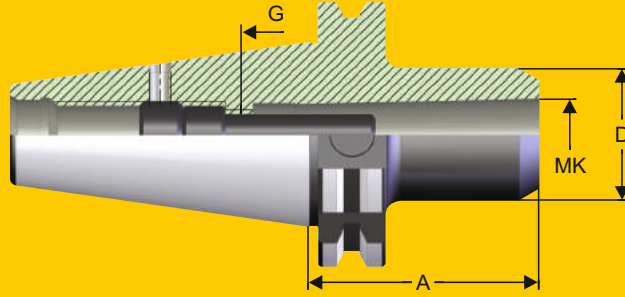

Sayfa : G-15  
Page : G-15



Sayfa : G-10  
Page : G-10



Sayfa : G-11  
Page : G-11

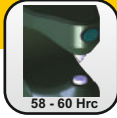

58 - 60 Hrc



V N5

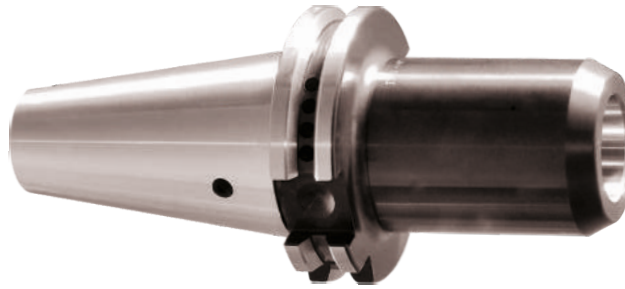

| SİPARİŞ KODU<br>Order Number | ÜRÜN ADI<br>Product Name       | MK<br>Morse | D  | A   | G   |
|------------------------------|--------------------------------|-------------|----|-----|-----|
| 564001                       | SK 40 ÇEKTİRMELİ MORS ADAPTÖRÜ | 1           | 25 | 50  | M6  |
| 564002                       | SK 40 ÇEKTİRMELİ MORS ADAPTÖRÜ | 2           | 32 | 55  | M10 |
| 564003                       | SK 40 ÇEKTİRMELİ MORS ADAPTÖRÜ | 3           | 40 | 70  | M12 |
| 564004                       | SK 40 ÇEKTİRMELİ MORS ADAPTÖRÜ | 4           | 48 | 95  | M16 |
| 565001                       | SK 50 ÇEKTİRMELİ MORS ADAPTÖRÜ | 1           | 25 | 45  | M6  |
| 565002                       | SK 50 ÇEKTİRMELİ MORS ADAPTÖRÜ | 2           | 32 | 60  | M10 |
| 565003                       | SK 50 ÇEKTİRMELİ MORS ADAPTÖRÜ | 3           | 40 | 65  | M12 |
| 565004                       | SK 50 ÇEKTİRMELİ MORS ADAPTÖRÜ | 4           | 48 | 85  | M16 |
| 565005                       | SK 50 ÇEKTİRMELİ MORS ADAPTÖRÜ | 5           | 63 | 118 | M20 |



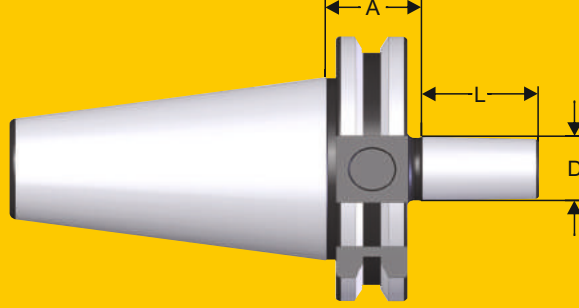

Sayfa : G-15  
Page : G-15



Sayfa : G-10  
Page : G-10



Sayfa : G-11  
Page : G-11

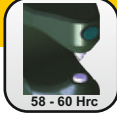



58 - 60 Hrc



V N5



| SİPARİŞ KODU<br>Order Number   | ÜRÜN ADI<br>Product Name | D   | A    | L    |
|--|--------------------------|-----|------|------|
|  573012 | SK 30 MANDREN ADAPTÖRÜ   | B12 | 38,5 | 18,5 |
|  573016 | SK 30 MANDREN ADAPTÖRÜ   | B16 | 40   | 24   |
| 574012   | SK 40 MANDREN ADAPTÖRÜ   | B12 | 25   | 18,5 |
| 574016   | SK 40 MANDREN ADAPTÖRÜ   | B16 | 25   | 24   |
| 574018   | SK 40 MANDREN ADAPTÖRÜ   | B18 | 35   | 32   |
| 575016   | SK 50 MANDREN ADAPTÖRÜ   | B16 | 25   | 24   |
| 575018   | SK 50 MANDREN ADAPTÖRÜ   | B18 | 25   | 32   |

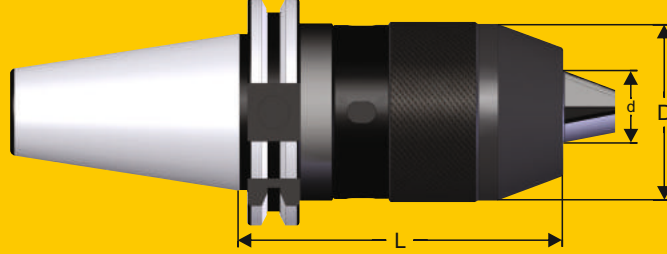

Sayfa : G-15  
Page : G-15



Sayfa : G-10  
Page : G-10



Sayfa : G-11  
Page : G-11

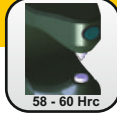

58 - 60 Hrc



VN5



| SİPARİŞ KODU<br>Order Number | ÜRÜN ADI<br>Product Name     | KAPASİTE<br>Capacity<br>d | D  | L  |
|------------------------------|------------------------------|---------------------------|----|----|
| 574116                       | SK 40 NC TİPİ MANDREN TUTUCU | 1.....16                  | 51 | 99 |
| 575116                       | SK 50 NC TİPİ MANDREN TUTUCU | 1.....16                  | 51 | 89 |

## DIN 69871 AD

KLAVUZ ÇEKME BAŞLIĞI  
GİRİŞ-ÇIKIŞ KOMPANZELİ

Quick-change tapping chucks  
with lenght compensation



# DEĞERLİ®

www.degerlimakina.com

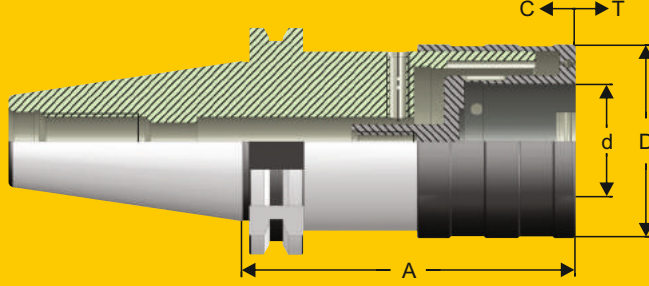

Sayfa : G-15  
Page : G-15



Sayfa / Page :  
G-05,06,07



Sayfa : G-10  
Page : G-10



Sayfa : G-11  
Page : G-11

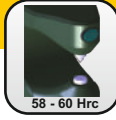

58 - 60 Hrc



V N5

NEW PRODUCT  
YENİ ÜRÜN



| SİPARİŞ KODU<br>Order Number | ÜRÜN ADI<br>Product Name            | d  | A   | D  | C    | T    |
|------------------------------|-------------------------------------|----|-----|----|------|------|
| 576214                       | SK 30 M2 / M14 EM.TİP KLV.ÇEK.BAŞ.  | 19 | 66  | 38 | 7    | 7    |
| 576524                       | SK 30 M5 / M24 EM.TİP KLV.ÇEK.BAŞ.  | 31 | 99  | 54 | 12   | 12   |
| 577214                       | SK 40 M2 / M14 EM.TİP KLV.ÇEK.BAŞ.  | 19 | 64  | 38 | 7    | 7    |
| 577524                       | SK 40 M5 / M24 EM.TİP KLV.ÇEK.BAŞ.  | 31 | 97  | 54 | 12   | 12   |
| 5771436                      | SK 40 M14 / M36 EM.TİP KLV.ÇEK.BAŞ. | 48 | 136 | 78 | 17,5 | 17,5 |
| 578214                       | SK 50 M2 / M14 EM.TİP KLV.ÇEK.BAŞ.  | 19 | 62  | 38 | 7    | 7    |
| 578524                       | SK 50 M5 / M24 EM.TİP KLV.ÇEK.BAŞ.  | 31 | 85  | 54 | 12   | 12   |
| 5781436                      | SK 50 M14 / M36 EM.TİP KLV.ÇEK.BAŞ. | 48 | 138 | 78 | 17,5 | 17,5 |

# DIN 69871 AD

VİDALI FREZE TAKIM TUTUCULARI  
Set holders for screw milling cutters



# DEĞERLİ®

www.degerlimakina.com

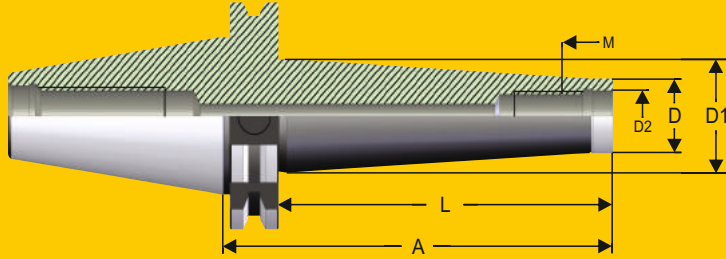

Sayfa : G-15  
Page : G-15



Sayfa : G-10  
Page : G-10



Sayfa : G-11  
Page : G-11

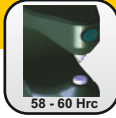

58 - 60 Hrc



V N5

STANDART  
BALANS  
G 2,5  
20000 min<sup>-1</sup>

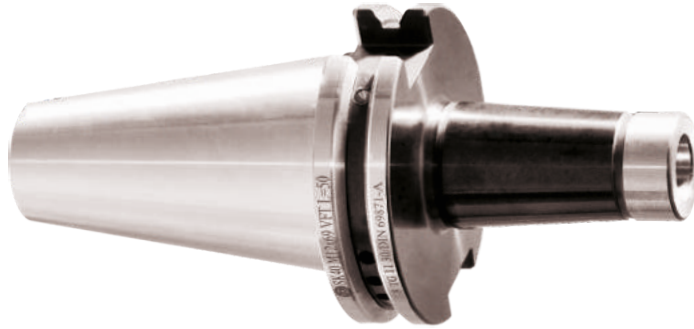

| SİPARİŞ KODU<br>Order Number | ÜRÜN ADI<br>Product Name  | M   | D  | D1 | A   | L   | D2   |
|------------------------------|---------------------------|-----|----|----|-----|-----|------|
| 584008                       | SK 40 VİDALI TAKIM TUTUCU | M8  | 13 | 23 | 69  | 50  | 8,5  |
| 584008.1                     | SK 40 VİDALI TAKIM TUTUCU | M8  | 13 | 25 | 119 | 100 | 8,5  |
| 584008.2                     | SK 40 VİDALI TAKIM TUTUCU | M8  | 13 | 30 | 169 | 150 | 8,5  |
| 584010                       | SK 40 VİDALI TAKIM TUTUCU | M10 | 18 | 23 | 69  | 50  | 10,5 |
| 584010.1                     | SK 40 VİDALI TAKIM TUTUCU | M10 | 18 | 32 | 119 | 100 | 10,5 |
| 584010.2                     | SK 40 VİDALI TAKIM TUTUCU | M10 | 18 | 36 | 169 | 150 | 10,5 |
| 584012                       | SK 40 VİDALI TAKIM TUTUCU | M12 | 21 | 24 | 69  | 50  | 12,5 |
| 584012.1                     | SK 40 VİDALI TAKIM TUTUCU | M12 | 21 | 33 | 119 | 100 | 12,5 |
| 584012.2                     | SK 40 VİDALI TAKIM TUTUCU | M12 | 21 | 40 | 169 | 150 | 12,5 |
| 584016                       | SK 40 VİDALI TAKIM TUTUCU | M16 | 29 | 34 | 94  | 75  | 17   |
| 584016.1                     | SK 40 VİDALI TAKIM TUTUCU | M16 | 29 | 40 | 144 | 125 | 17   |

## DIN 69871 AD

VİDALI FREZE TAKIM TUTUCULARI  
Set holders for screw milling cutters



# DEĞERLİ®

www.degerlimakina.com

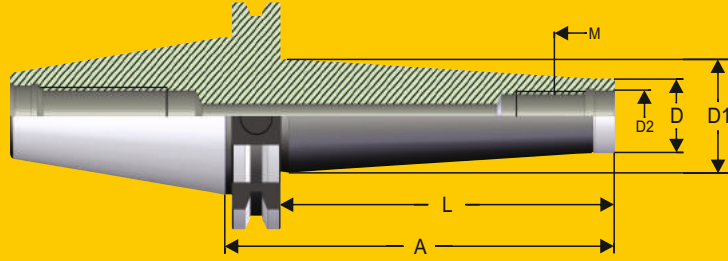

Sayfa : G-15  
Page : G-15



Sayfa : G-10  
Page : G-10



Sayfa : G-11  
Page : G-11

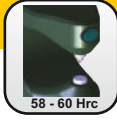

58 - 60 Hrc



V N5

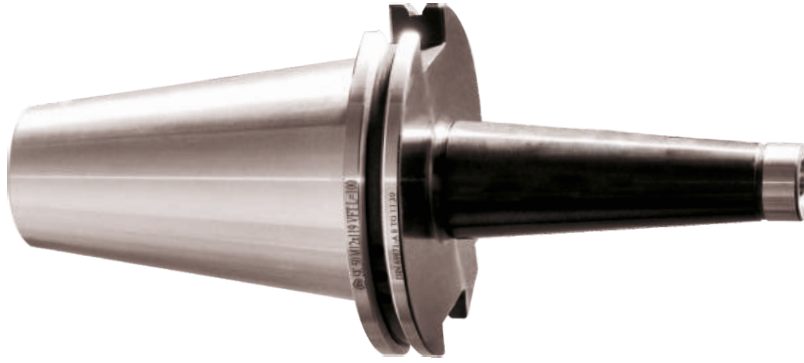

| SİPARİŞ KODU<br>Order Number | ÜRÜN ADI<br>Product Name  | M   | D  | D1 | A   | L   | D2   |
|------------------------------|---------------------------|-----|----|----|-----|-----|------|
| 585008                       | SK 50 VİDALI TAKIM TUTUCU | M8  | 13 | 25 | 119 | 100 | 8,5  |
| 585008.1                     | SK 50 VİDALI TAKIM TUTUCU | M8  | 13 | 30 | 169 | 150 | 8,5  |
| 585010                       | SK 50 VİDALI TAKIM TUTUCU | M10 | 18 | 32 | 119 | 100 | 10,5 |
| 585010.1                     | SK 50 VİDALI TAKIM TUTUCU | M10 | 18 | 36 | 169 | 150 | 10,5 |
| 585012                       | SK 50 VİDALI TAKIM TUTUCU | M12 | 21 | 33 | 119 | 100 | 12,5 |
| 585012.1                     | SK 50 VİDALI TAKIM TUTUCU | M12 | 21 | 40 | 169 | 150 | 12,5 |
| 585016                       | SK 50 VİDALI TAKIM TUTUCU | M16 | 29 | 36 | 119 | 100 | 17   |
| 585016.1                     | SK 50 VİDALI TAKIM TUTUCU | M16 | 29 | 42 | 169 | 150 | 17   |



## DIN 69871 AD

ÖZEL TAKIM YAPMAK İÇİN YUMUŞAK BARA MİLİ  
Boring bar blanks for producing special tools



# DEĞERLİ®

www.degerlimakina.com

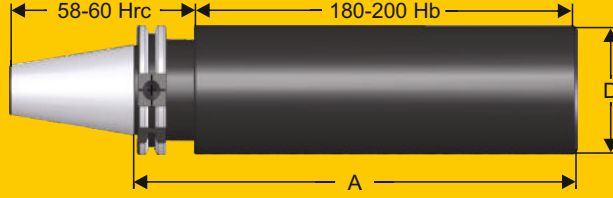

Sayfa : G-15  
Page : G-15



Sayfa : G-10  
Page : G-10



Sayfa : G-11  
Page : G-11

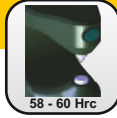

58 - 60 Hrc



V N5



| SİPARİŞ KODU<br>Order Number | ÜRÜN ADI<br>Product Name       | D  | A   |
|------------------------------|--------------------------------|----|-----|
| 594000                       | SK 40 ÖZEL TAKIM HAM BARA MİLİ | 63 | 250 |
| 595000                       | SK 50 ÖZEL TAKIM HAM BARA MİLİ | 97 | 315 |

## DIN 69871 AD

AHŞAP KUTULU PENS TAKIMI DIN 6388 B  
Collet set in wooden box DIN 6388 form B



# DEĞERLİ®



www.degerlimakina.com



Sayfa : G-10  
Page : G-10



Sayfa : G-11  
Page : G-11

| SİPARİŞ KODU<br>Order Number   | ÜRÜN ADI<br>Product Name | KAPASİTE<br>Capacity | PENS ADEDİ<br>Collet Piece |
|--|--------------------------|----------------------|----------------------------|
|  593415 | SK 30 / 415 PENS TAKIMI  | 3.....16 mm          | 12                         |
|  593462 | SK 30 / 462 PENS TAKIMI  | 4.....25 mm          | 16                         |
| 594415   | SK 40 / 415 PENS TAKIMI  | 3.....16 mm          | 12                         |
| 594462   | SK 40 / 462 PENS TAKIMI  | 4.....25 mm          | 16                         |
| 594467   | SK 40 / 467 PENS TAKIMI  | 5.....32 mm          | 16                         |
| 595462   | SK 50 / 462 PENS TAKIMI  | 4.....25 mm          | 16                         |
| 595467   | SK 50 / 467 PENS TAKIMI  | 5.....32 mm          | 16                         |

## DIN 69871 AD

AHŞAP KUTULU PENS TAKIMI DIN 6499 ER  
Collet set in wooden box DIN 6499 ER



# DEĞERLİ®

www.degerlimakina.com



Sayfa : G-10  
Page : G-10



Sayfa : G-11  
Page : G-11

| SİPARİŞ KODU<br>Order Number   | ÜRÜN ADI<br>Product Name      | KAPASİTE<br>Capacity | PENS ADEDİ<br>Collet Piece |
|--|-------------------------------|----------------------|----------------------------|
|  593430 | SK 30 / ER 25 430 PENS TAKIMI | 3.....16 mm          | 14                         |
|  593470 | SK 30 / ER 32 470 PENS TAKIMI | 3.....20 mm          | 14                         |
|  593472 | SK 30 / ER 40 472 PENS TAKIMI | 4.....26 mm          | 16                         |
| 594430   | SK 40 / ER 25 430 PENS TAKIMI | 3.....16 mm          | 14                         |
| 594470   | SK 40 / ER 32 470 PENS TAKIMI | 3.....20 mm          | 14                         |
| 594472   | SK 40 / ER 40 472 PENS TAKIMI | 4.....26 mm          | 16                         |
| 595430   | SK 50 / ER 25 430 PENS TAKIMI | 3.....16 mm          | 14                         |
| 595470   | SK 50 / ER 32 470 PENS TAKIMI | 3.....20 mm          | 14                         |
| 595472   | SK 50 / ER 40 472 PENS TAKIMI | 4.....26 mm          | 16                         |

## DIN 69871 AD

AHŞAP KUTULU RULMANLI PENS TAKIMI  
Collet set in wooden box



# DEĞERLİ®

www.degerlimakina.com



Sayfa : G-10  
Page : G-10



Sayfa : G-11  
Page : G-11

| SİPARİŞ KODU<br>Order Number | ÜRÜN ADI<br>Product Name   | KAPASİTE<br>Capacity<br>( d ) | PENS ADEDİ<br>Collet Piece |
|------------------------------|----------------------------|-------------------------------|----------------------------|
| 598420                       | SK 40 RULMANLI PENS TAKIMI | 6.....20 mm                   | 5                          |
| 598432                       | SK 40 RULMANLI PENS TAKIMI | 6.....32 mm                   | 7                          |
| 599520                       | SK 50 RULMANLI PENS TAKIMI | 6.....20 mm                   | 5                          |
| 599532                       | SK 50 RULMANLI PENS TAKIMI | 6.....32 mm                   | 7                          |









**DIN 228-1 FORM-A / FORM-B**  
**mk başlıklar**  
**mk toolholders**



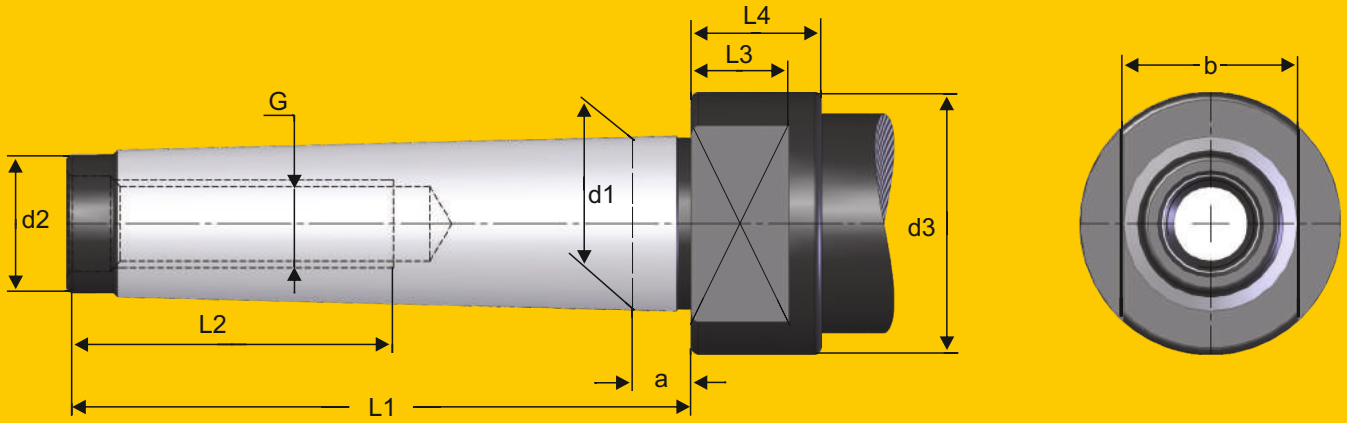

| ÜRÜN ADI<br>Product Name | d1     | a   | G   | d2   | d3 | b  | I1  | I2 | I3 | I4 |
|--------------------------|--------|-----|-----|------|----|----|-----|----|----|----|
| MK 2                     | 17,780 | 5   | M10 | 14   | -  | -  | 69  | 24 | -  | -  |
| MK 3                     | 23,825 | 5   | M12 | 19   | 36 | 24 | 86  | 28 | 12 | 18 |
| MK 4                     | 31,267 | 6,5 | M16 | 25   | 43 | 32 | 109 | 32 | 15 | 23 |
| MK 5                     | 44,399 | 6,5 | M20 | 35,7 | 60 | 45 | 136 | 40 | 18 | 28 |

# DIN 228 - 1 FORM A

PENS BAŞLIĞI DIN 6391 PENS 6388

Collet chucks DIN 6391 for Collets DIN 6388



# DEĞERLİ®

www.degerlimakina.com

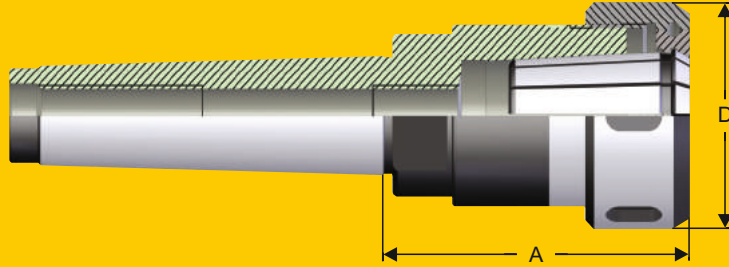

Sayfa : G-01  
Page : G-01



Sayfa / Page :  
A-07,09,10,11



Sayfa : G-12  
Page : G-12



Sayfa : F-04  
Page : F-04

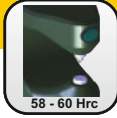

58 - 60 Hrc



V N5



| SİPARİŞ KODU<br>Order Number | ÜRÜN ADI<br>Product Name    | KAPASİTE<br>Capacity | D  | A   |
|------------------------------|-----------------------------|----------------------|----|-----|
| 612415                       | MK 2 / M10 415 PENS BAŞLIĞI | 2.....16             | 43 | 69  |
| 613415                       | MK 3 / M12 415 PENS BAŞLIĞI | 2.....16             | 43 | 84  |
| 613462                       | MK 3 / M12 462 PENS BAŞLIĞI | 2.....25             | 60 | 89  |
| 614462                       | MK 4 / M16 462 PENS BAŞLIĞI | 2.....25             | 60 | 89  |
| 614467                       | MK 4 / M16 467 PENS BAŞLIĞI | 3.....32             | 72 | 109 |
| 615462                       | MK 5 / M20 462 PENS BAŞLIĞI | 2.....25             | 60 | 89  |
| 615467                       | MK 5 / M20 467 PENS BAŞLIĞI | 3.....32             | 72 | 114 |
| 615468                       | MK 5 / M20 468 PENS BAŞLIĞI | 3.....40             | 85 | 119 |

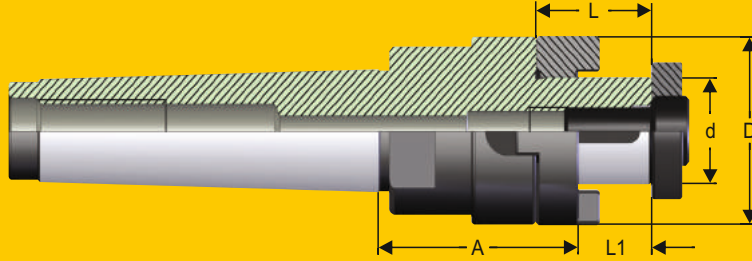

Sayfa : G-08  
Page : G-08



Sayfa : G-09  
Page : G-09

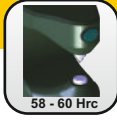

58 - 60 Hrc



V N6

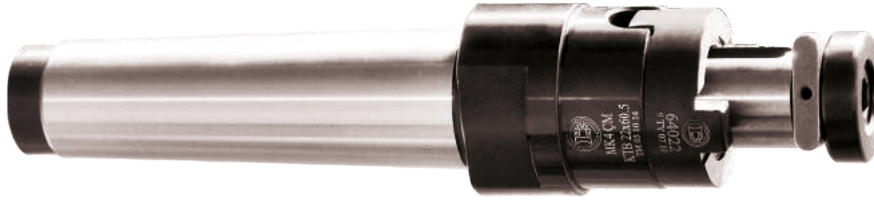

| SİPARİŞ KODU<br>Order Number | ÜRÜN ADI<br>Product Name | d<br>h6 | D  | A  | L  | L1 |
|------------------------------|--------------------------|---------|----|----|----|----|
| 620416                       | MK 4 / M16 / K.T.B. 16   | 16      | 32 | 60 | 27 | 17 |
| 620422                       | MK 4 / M16 / K.T.B. 22   | 22      | 40 | 60 | 31 | 19 |
| 620427                       | MK 4 / M16 / K.T.B. 27   | 27      | 48 | 60 | 33 | 21 |
| 620432                       | MK 4 / M16 / K.T.B. 32   | 32      | 58 | 60 | 38 | 24 |
| 620440                       | MK 4 / M16 / K.T.B. 40   | 40      | 70 | 60 | 41 | 27 |
| 620516                       | MK 5 / M20 / K.T.B. 16   | 16      | 32 | 65 | 27 | 17 |
| 620522                       | MK 5 / M20 / K.T.B. 22   | 22      | 40 | 65 | 31 | 19 |
| 620527                       | MK 5 / M20 / K.T.B. 27   | 27      | 48 | 65 | 33 | 21 |
| 620532                       | MK 5 / M20 / K.T.B. 32   | 32      | 58 | 65 | 38 | 24 |
| 620540                       | MK 5 / M20 / K.T.B. 40   | 40      | 70 | 65 | 41 | 27 |

## DIN 228 - 1 FORM A

AHŞAP KUTULU PENS TAKIMI DIN 6388 B  
Collet set in wooden box DIN 6388 form B



# DEĞERLİ®

www.degerlimakina.com



| SİPARİŞ KODU<br>Order Number | ÜRÜN ADI<br>Product Name   | KAPASİTE<br>Capacity | PENS ADEDİ<br>Collet Piece |
|------------------------------|----------------------------|----------------------|----------------------------|
| 692415                       | MK 2 / M10 415 PENS TAKIMI | 3.....16 mm          | 12                         |
| 693415                       | MK 3 / M12 415 PENS TAKIMI | 3.....16 mm          | 12                         |
| 693462                       | MK 3 / M12 462 PENS TAKIMI | 4.....25 mm          | 16                         |
| 694462                       | MK 4 / M16 462 PENS TAKIMI | 4.....25 mm          | 16                         |
| 694467                       | MK 4 / M16 467 PENS TAKIMI | 5.....32 mm          | 16                         |
| 695462                       | MK 5 / M20 462 PENS TAKIMI | 4.....25 mm          | 16                         |
| 695467                       | MK 5 / M20 467 PENS TAKIMI | 5.....32 mm          | 16                         |
| 695468                       | MK 5 / M20 468 PENS TAKIMI | 6.....40 mm          | 20                         |



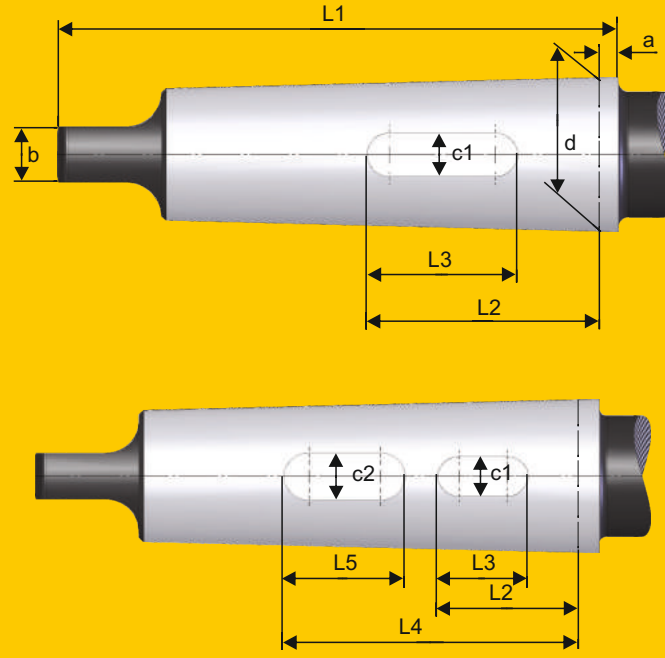

| ÜRÜN ADI<br>Product Name | d      | a   | b    | L1  | L2   | L3 | L4  | L5 | c1   | c2   |
|--------------------------|--------|-----|------|-----|------|----|-----|----|------|------|
| MK 3                     | 23,825 | 5   | 7,9  | 99  | 55,5 | 32 | —   | —  | 8,3  | —    |
| MK 4                     | 31,267 | 6,5 | 11,9 | 124 | 59,5 | 37 | —   | —  | 8,3  | —    |
| MK 5                     | 44,399 | 6,5 | 15,9 | 156 | 64   | 42 | —   | —  | 12,4 | —    |
| MK 6                     | 63,348 | 8   | 19   | 218 | 56   | 35 | 122 | 47 | 16,4 | 19,5 |

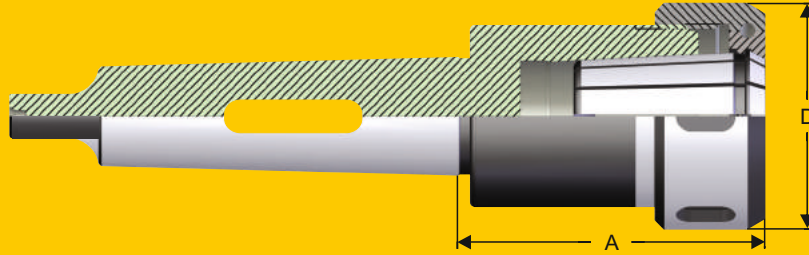

Sayfa : G-01  
Page : G-01



Sayfa / Page :  
A-09,10,11



Sayfa : G-12  
Page : G-12

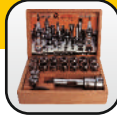

Sayfa : F-08  
Page : F-08

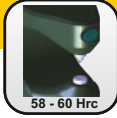

58 - 60 Hrc



V N5

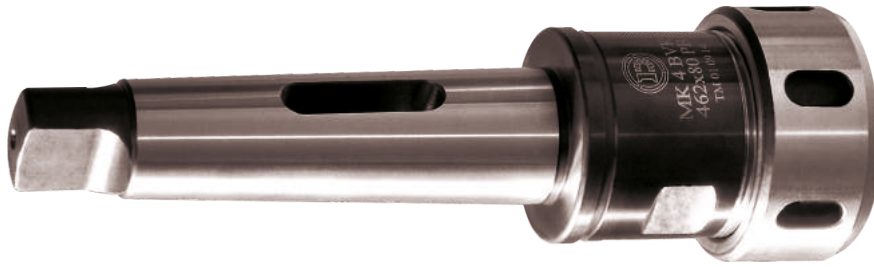

| SİPARİŞ KODU<br>Order Number | ÜRÜN ADI<br>Product Name     | KAPASİTE<br>Capacity | D  | A   |
|------------------------------|------------------------------|----------------------|----|-----|
| 713462                       | MK 3 BORVEK 462 PENS BAŞLIĞI | 2.....25mm           | 60 | 75  |
| 714462                       | MK 4 BORVEK 462 PENS BAŞLIĞI | 2.....25 mm          | 60 | 84  |
| 714467                       | MK 4 BORVEK 467 PENS BAŞLIĞI | 3.....32 mm          | 72 | 94  |
| 715462                       | MK 5 BORVEK 462 PENS BAŞLIĞI | 2.....25 mm          | 60 | 84  |
| 715467                       | MK 5 BORVEK 467 PENS BAŞLIĞI | 3.....32 mm          | 72 | 90  |
| 715468                       | MK 5 BORVEK 468 PENS BAŞLIĞI | 3.....40 mm          | 85 | 100 |
| 716467                       | MK 6 BORVEK 467 PENS BAŞLIĞI | 3.....32 mm          | 72 | 90  |
| 716468                       | MK 6 BORVEK 468 PENS BAŞLIĞI | 3.....40 mm          | 85 | 94  |

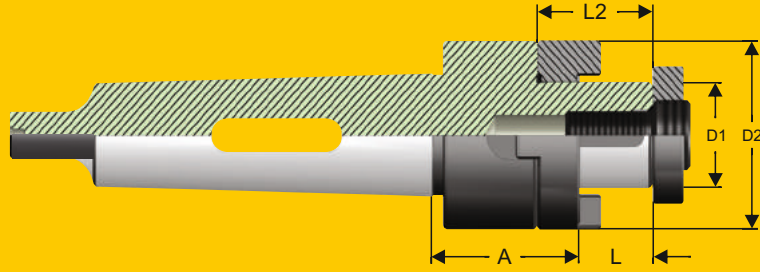

Sayfa : G-08  
Page : G-08



Sayfa : G-09  
Page : G-09

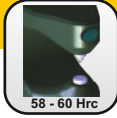

58 - 60 Hrc



V N5

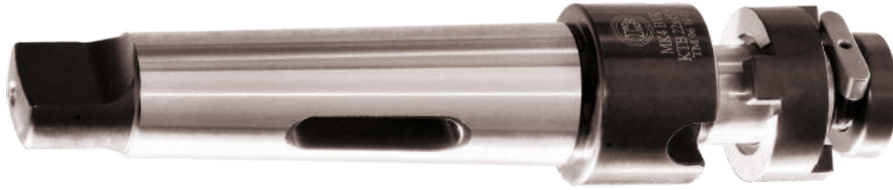

| SİPARİŞ KODU<br>Order Number | ÜRÜN ADI<br>Product Name  | D1<br>h6 | D2 | A  | L  | L2 |
|------------------------------|---------------------------|----------|----|----|----|----|
| 720416                       | MK 4 / BORVEK / K.T.B. 16 | 16       | 32 | 45 | 17 | 27 |
| 720422                       | MK 4 / BORVEK / K.T.B. 22 | 22       | 40 | 45 | 19 | 31 |
| 720427                       | MK 4 / BORVEK / K.T.B. 27 | 27       | 48 | 45 | 21 | 33 |
| 720432                       | MK 4 / BORVEK / K.T.B. 32 | 32       | 58 | 45 | 24 | 38 |
| 720440                       | MK 4 / BORVEK / K.T.B. 40 | 40       | 70 | 45 | 27 | 41 |
| 720516                       | MK 5 / BORVEK / K.T.B. 16 | 16       | 32 | 45 | 17 | 27 |
| 720522                       | MK 5 / BORVEK / K.T.B. 22 | 22       | 40 | 45 | 19 | 31 |
| 720527                       | MK 5 / BORVEK / K.T.B. 27 | 27       | 48 | 45 | 21 | 33 |
| 720532                       | MK 5 / BORVEK / K.T.B. 32 | 32       | 58 | 45 | 24 | 38 |
| 720540                       | MK 5 / BORVEK / K.T.B. 40 | 40       | 70 | 45 | 27 | 41 |
| 720622                       | MK 6 / BORVEK / K.T.B. 22 | 22       | 40 | 50 | 19 | 31 |
| 720627                       | MK 6 / BORVEK / K.T.B. 27 | 27       | 48 | 50 | 21 | 33 |
| 720632                       | MK 6 / BORVEK / K.T.B. 32 | 32       | 58 | 50 | 24 | 38 |
| 720640                       | MK 6 / BORVEK / K.T.B. 40 | 40       | 70 | 50 | 27 | 41 |

**DIN 228 - 1 DIN 1806 FORM B**  
AHŞAP KUTULU PENS TAKIMI DIN 6388 B  
Collet set in wooden box DIN 6388 form B



**DEĞERLİ®**  
www.degerlimakina.com



| SİPARİŞ KODU<br>Order Number | ÜRÜN ADI<br>Product Name        | KAPASİTE<br>Capacity | PENS ADEDİ<br>Collet Piece |
|------------------------------|---------------------------------|----------------------|----------------------------|
| 793462                       | MK 3 / BORVEK / 462 PENS TAKIMI | 4.....25 mm          | 16                         |
| 794462                       | MK 4 / BORVEK / 462 PENS TAKIMI | 4.....25 mm          | 16                         |
| 794467                       | MK 4 / BORVEK / 467 PENS TAKIMI | 5.....32 mm          | 16                         |
| 795462                       | MK 5 / BORVEK / 462 PENS TAKIMI | 4.....25 mm          | 16                         |
| 795467                       | MK 5 / BORVEK / 467 PENS TAKIMI | 5.....32 mm          | 16                         |
| 795468                       | MK 5 / BORVEK / 468 PENS TAKIMI | 6.....40 mm          | 20                         |
| 796467                       | MK 6 / BORVEK / 467 PENS TAKIMI | 5.....32 mm          | 16                         |
| 796468                       | MK 6 / BORVEK / 468 PENS TAKIMI | 6.....40 mm          | 20                         |





**DEĞERLİ**

[www.degerlimakina.com](http://www.degerlimakina.com)

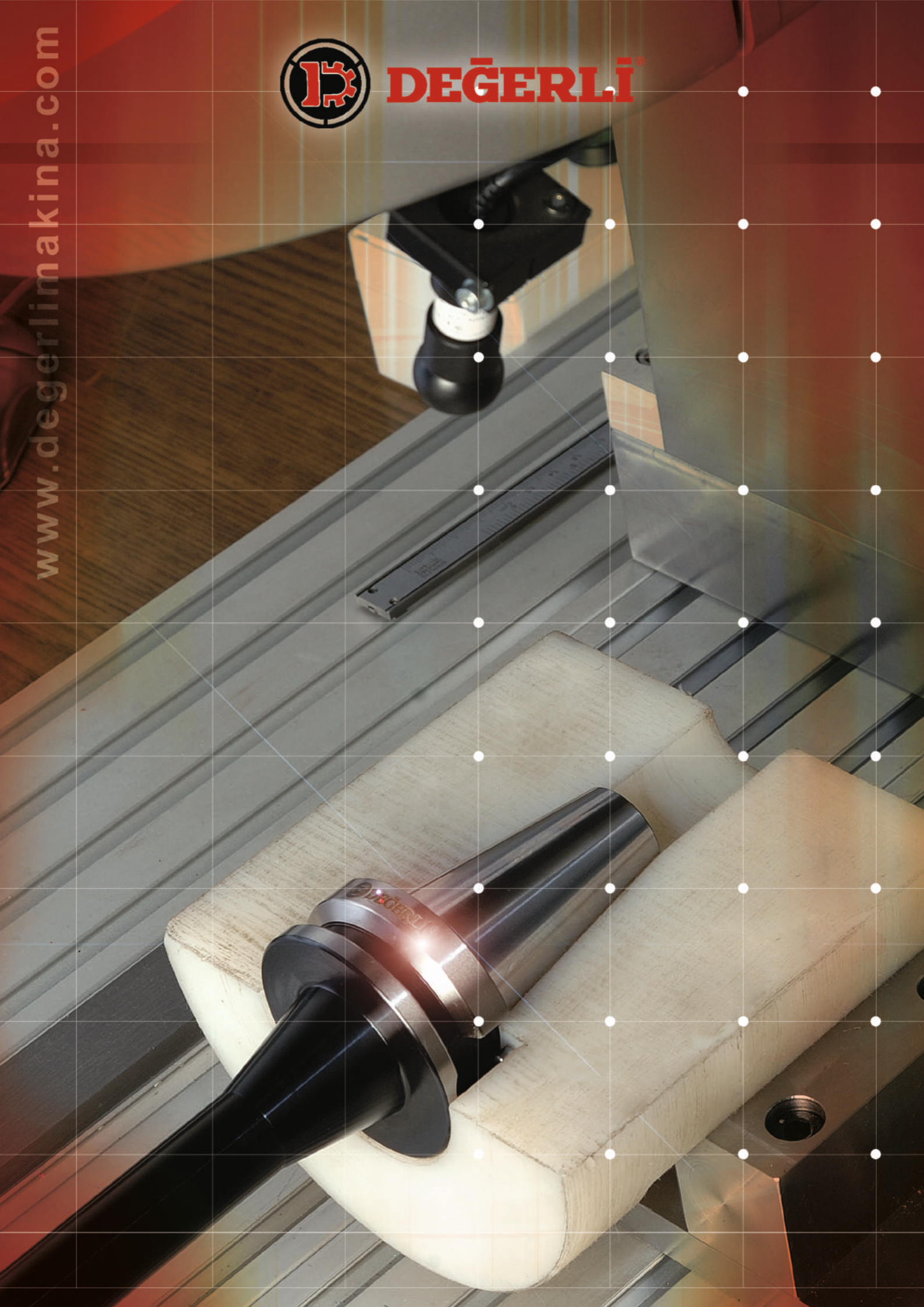





**diğer ürünler**  
**accessories**





Sayfa / Page :  
A-07,08,09,10,11,12,13



Sayfa : G-12  
Page : G-12



Sayfa : G-10  
Page : G-10



Sayfa : G-11  
Page : G-11



| SİPARİŞ KODU<br>Order Number | ÜRÜN ADI<br>Product Name                     | d  | D  |
|------------------------------|--|----|----|
| 904042                       | AY ANAHTARI / 415                            | 40 | 42 |
| 904550                       | AY ANAHTARI RULMANLI TAKIM İÇİN ( 6.....20 ) | 45 | 50 |
| 904550                       | AY ANAHTARI 440                              | 45 | 50 |
| 905862                       | AY ANAHTARI 462                              | 58 | 62 |
| 906875                       | AY ANAHTARI 467                              | 68 | 75 |
| 906875                       | AY ANAHTARI RULMANLI TAKIM İÇİN ( 6.....32 ) | 68 | 75 |
| 908590                       | AY ANAHTARI 468                              | 85 | 90 |

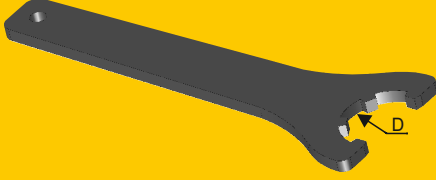

Sayfa / Page :  
A-01,02,03,04,05



Sayfa : G-13  
Page : G-13



Sayfa : G-13  
Page : G-13



Sayfa : G-10  
Page : G-10



Sayfa : G-11  
Page : G-11



NEW PRODUCT  
YENİ ÜRÜN

| SİPARİŞ KODU<br>Order Number | ÜRÜN ADI<br>Product Name     | KAPASİTE<br>Capacity<br>D |
|------------------------------|------------------------------|---------------------------|
| 9022426                      | 426 ( ER 16 ) KAPAK ANAHTARI | 22                        |
| 9032426                      | 426 ( ER 16 ) KAPAK ANAHTARI | 32                        |
| 9035428                      | 428 ( ER 20 ) KAPAK ANAHTARI | 35                        |
| 9042430                      | 430 ( ER 25 ) KAPAK ANAHTARI | 42                        |
| 9050470                      | 470 ( ER 32 ) KAPAK ANAHTARI | 50                        |
| 9063472                      | 472 ( ER 40 ) KAPAK ANAHTARI | 63                        |

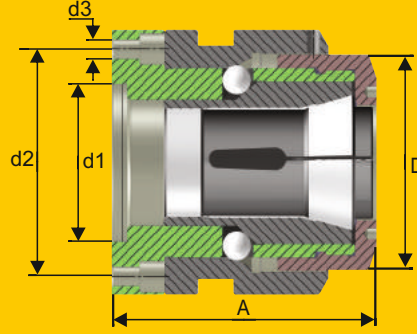

Sayfa : A-14  
Page : A-14



Sayfa : A-14  
Page : A-14



Sayfa : A-14  
Page : A-14

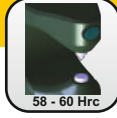

58 - 60 Hrc



VN5

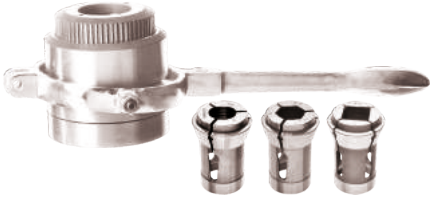
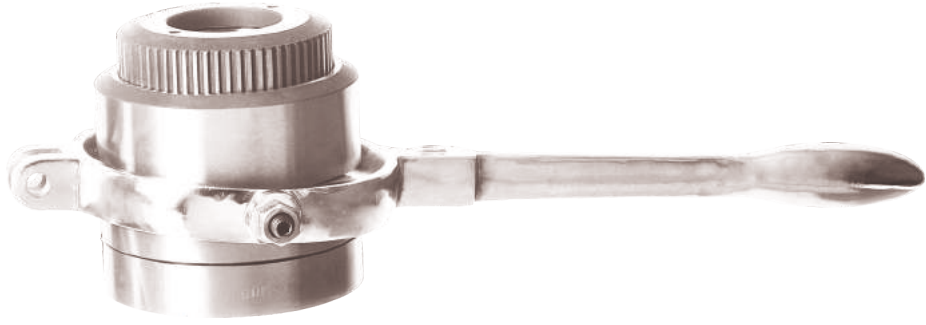

SİPARİŞ KODU  
Order Number

ÜRÜN ADI  
Product Name

MAX.DEVİR  
Max. Rpm.

D

d1

Lk Ø

d2

A

d3

92040

MBPA / 40-S / 173 D

2000

96

70

101

6 x 8,5

130

8,5



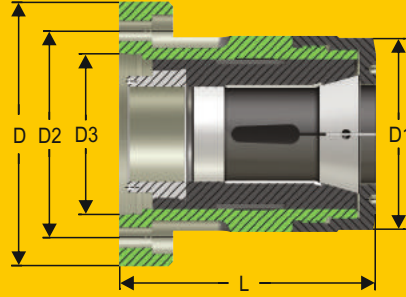
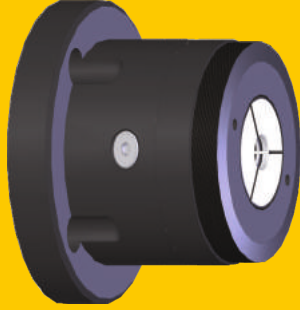

Sayfa : A-14  
Page : A-14



Sayfa : A-14  
Page : A-14



Sayfa : A-14  
Page : A-14

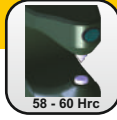

58 - 60 Hrc



VN5



| SİPARİŞ KODU<br>Order Number | ÜRÜN ADI<br>Product Name | MAX.DEVİR<br>Max. Rpm. | D   | L   | D1  | D3   | D2    | PENS KODU<br>Collet Nr. |
|------------------------------|--------------------------|------------------------|-----|-----|-----|------|-------|-------------------------|
| 93040                        | H.P.A. 40 / 5            | 5000                   | 135 | 132 | 100 | 6 "  | 104,8 | 173 D                   |
| 93140                        | H.P.A. 40 / 6            | 5000                   | 165 | 134 | 118 | 8 "  | 133,4 | 173 D                   |
| 93060                        | H.P.A. 60 / 6            | 4500                   | 165 | 151 | 122 | 8 "  | 133,4 | 185 D                   |
| 93160                        | H.P.A. 60 / 8            | 4000                   | 208 | 154 | 138 | 10 " | 171,4 | 185 D                   |



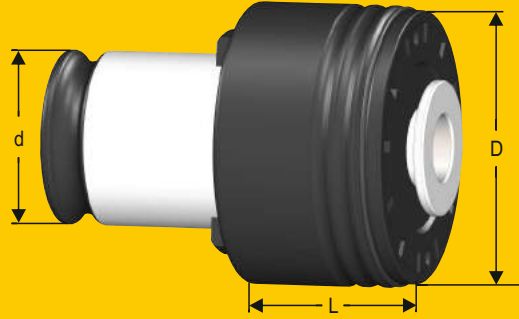

Sayfa : C-23  
Page : C-23



Sayfa : D-12  
Page : D-12



Sayfa : E-22  
Page : E-22

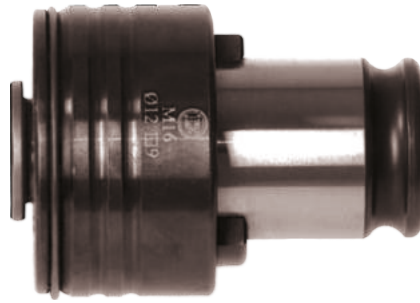
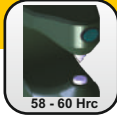

| SİPARİŞ KODU<br>Order Number | ÜRÜN ADI<br>Product Name                          | D  | d  | L  | KARE<br>Square |
|------------------------------|---|----|----|----|----------------|
| 8 19 28.M2                   | ŞAFT Ø 2,8 M2 KLAVUZ İÇİN EMNİYETLİ TİP ADAPTÖR   | 32 | 19 | 25 | 2,1            |
| 8 19 28.M2,5                 | ŞAFT Ø 2,8 M2,5 KLAVUZ İÇİN EMNİYETLİ TİP ADAPTÖR | 32 | 19 | 25 | 2,1            |
| 8 19 35.M3                   | ŞAFT Ø 3,5 M3 KLAVUZ İÇİN EMNİYETLİ TİP ADAPTÖR   | 32 | 19 | 25 | 2,7            |
| 8 19 40.M3,5                 | ŞAFT Ø 4 M3,5 KLAVUZ İÇİN EMNİYETLİ TİP ADAPTÖR   | 32 | 19 | 25 | 3,0            |
| 8 19 45.M4                   | ŞAFT Ø 4,5 M4 KLAVUZ İÇİN EMNİYETLİ TİP ADAPTÖR   | 32 | 19 | 25 | 3,4            |
| 8 19 60.M5                   | ŞAFT Ø 6 M5 KLAVUZ İÇİN EMNİYETLİ TİP ADAPTÖR     | 32 | 19 | 25 | 4,9            |
| 8 19 60.M6                   | ŞAFT Ø 6 M6 KLAVUZ İÇİN EMNİYETLİ TİP ADAPTÖR     | 32 | 19 | 25 | 4,9            |
| 8 19 80.M8                   | ŞAFT Ø 8 M8 KLAVUZ İÇİN EMNİYETLİ TİP ADAPTÖR     | 32 | 19 | 25 | 6,2            |
| 8 19 70.M10                  | ŞAFT Ø 7 M10 KLAVUZ İÇİN EMNİYETLİ TİP ADAPTÖR    | 32 | 19 | 25 | 5,5            |
| 8 19 10.M10                  | ŞAFT Ø 10 M10 KLAVUZ İÇİN EMNİYETLİ TİP ADAPTÖR   | 32 | 19 | 25 | 8,0            |
| 8 19 90.M12                  | ŞAFT Ø 9 M12 KLAVUZ İÇİN EMNİYETLİ TİP ADAPTÖR    | 32 | 19 | 25 | 7,0            |
| 8 19 11.M14                  | ŞAFT Ø 11 M14 KLAVUZ İÇİN EMNİYETLİ TİP ADAPTÖR   | 32 | 19 | 25 | 9,0            |

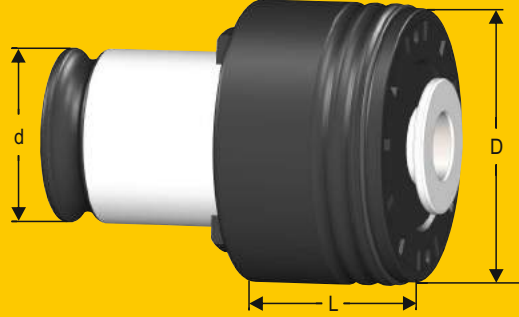

Sayfa : C-23  
Page : C-23



Sayfa : D-12  
Page : D-12



Sayfa : E-22  
Page : E-22

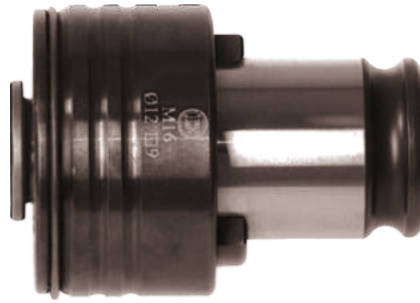
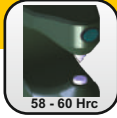

| SİPARİŞ KODU<br>Order Number | ÜRÜN ADI<br>Product Name                        | D  | d  | L  | KARE<br>Square |
|------------------------------|---|----|----|----|----------------|
| 8 31 60.M5                   | ŞAFT Ø 6 M5 KLAVUZ İÇİN EMNİYETLİ TİP ADAPTÖR   | 50 | 31 | 31 | 4,9            |
| 8 31 60.M6                   | ŞAFT Ø 6 M6 KLAVUZ İÇİN EMNİYETLİ TİP ADAPTÖR   | 50 | 31 | 31 | 4,9            |
| 8 31 80.M8                   | ŞAFT Ø 8 M8 KLAVUZ İÇİN EMNİYETLİ TİP ADAPTÖR   | 50 | 31 | 31 | 6,2            |
| 8 31 70.M10                  | ŞAFT Ø 7 M10 KLAVUZ İÇİN EMNİYETLİ TİP ADAPTÖR  | 50 | 31 | 31 | 5,5            |
| 8 31 10.M10                  | ŞAFT Ø 10 M10 KLAVUZ İÇİN EMNİYETLİ TİP ADAPTÖR | 50 | 31 | 31 | 8,0            |
| 8 31 90.M12                  | ŞAFT Ø 9 M12 KLAVUZ İÇİN EMNİYETLİ TİP ADAPTÖR  | 50 | 31 | 31 | 7,0            |
| 8 31 11.M14                  | ŞAFT Ø 11 M14 KLAVUZ İÇİN EMNİYETLİ TİP ADAPTÖR | 50 | 31 | 31 | 9,0            |
| 8 31 12.M16                  | ŞAFT Ø 12 M16 KLAVUZ İÇİN EMNİYETLİ TİP ADAPTÖR | 50 | 31 | 31 | 9,0            |
| 8 31 14.M18                  | ŞAFT Ø 14 M18 KLAVUZ İÇİN EMNİYETLİ TİP ADAPTÖR | 50 | 31 | 31 | 11,0           |
| 8 31 16.M20                  | ŞAFT Ø 16 M20 KLAVUZ İÇİN EMNİYETLİ TİP ADAPTÖR | 50 | 31 | 31 | 12,0           |
| 8 31 18.M22                  | ŞAFT Ø 18 M22 KLAVUZ İÇİN EMNİYETLİ TİP ADAPTÖR | 50 | 31 | 31 | 14,5           |
| 8 31 18.M24                  | ŞAFT Ø 18 M24 KLAVUZ İÇİN EMNİYETLİ TİP ADAPTÖR | 50 | 31 | 31 | 14,5           |

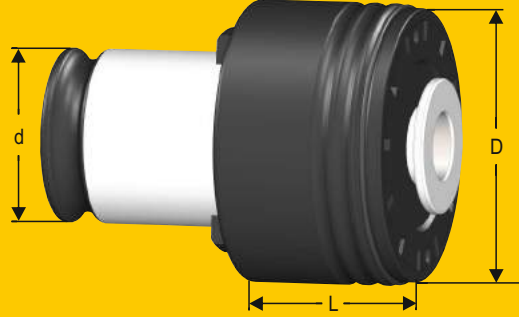

Sayfa : C-23  
Page : C-23



Sayfa : D-12  
Page : D-12



Sayfa : E-22  
Page : E-22

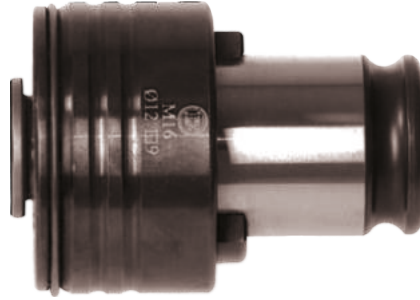
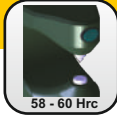

| SİPARİŞ KODU<br>Order Number | ÜRÜN ADI<br>Product Name                        | D  | d  | L  | KARE<br>Square |
|------------------------------|---|----|----|----|----------------|
| 8 48 11.M14                  | ŞAFT Ø 11 M14 KLAVUZ İÇİN EMNİYETLİ TİP ADAPTÖR | 72 | 48 | 41 | 9,0            |
| 8 48 12.M16                  | ŞAFT Ø 12 M16 KLAVUZ İÇİN EMNİYETLİ TİP ADAPTÖR | 72 | 48 | 41 | 9,0            |
| 8 48 14.M18                  | ŞAFT Ø 14 M18 KLAVUZ İÇİN EMNİYETLİ TİP ADAPTÖR | 72 | 48 | 41 | 11,0           |
| 8 48 16.M20                  | ŞAFT Ø 16 M20 KLAVUZ İÇİN EMNİYETLİ TİP ADAPTÖR | 72 | 48 | 41 | 12,0           |
| 8 48 18.M22                  | ŞAFT Ø 18 M22 KLAVUZ İÇİN EMNİYETLİ TİP ADAPTÖR | 72 | 48 | 41 | 14,5           |
| 8 48 18.M24                  | ŞAFT Ø 18 M24 KLAVUZ İÇİN EMNİYETLİ TİP ADAPTÖR | 72 | 48 | 41 | 14,5           |
| 8 48 20.M27                  | ŞAFT Ø 20 M27 KLAVUZ İÇİN EMNİYETLİ TİP ADAPTÖR | 72 | 48 | 41 | 16,0           |
| 8 48 22.M30                  | ŞAFT Ø 22 M30 KLAVUZ İÇİN EMNİYETLİ TİP ADAPTÖR | 72 | 48 | 41 | 18,0           |
| 8 48 25.M33                  | ŞAFT Ø 25 M33 KLAVUZ İÇİN EMNİYETLİ TİP ADAPTÖR | 72 | 48 | 41 | 20,0           |
| 8 48 28.M36                  | ŞAFT Ø 28 M36 KLAVUZ İÇİN EMNİYETLİ TİP ADAPTÖR | 72 | 48 | 41 | 22,0           |

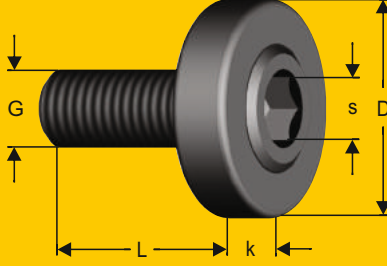

Sayfa : G-09  
Page : G-09



Sayfa : G-10  
Page : G-10



Sayfa : G-11  
Page : G-11

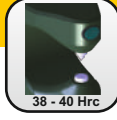

38 - 40 Hrc

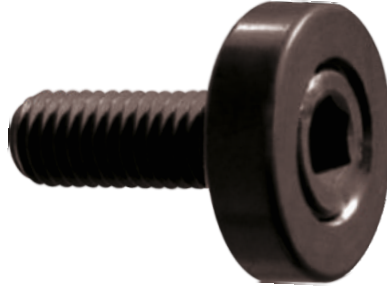

| SİPARİŞ KODU<br>Order Number | ÜRÜN ADI<br>Product Name | G   | D  | k  | L  | sw |
|------------------------------|--------------------------|-----|----|----|----|----|
| 60816                        | TARAMA KİLİT VİDASI 16   | M8  | 20 | 6  | 16 | 6  |
| 61022                        | TARAMA KİLİT VİDASI 22   | M10 | 28 | 7  | 18 | 8  |
| 61227                        | TARAMA KİLİT VİDASI 27   | M12 | 35 | 8  | 22 | 10 |
| 61632                        | TARAMA KİLİT VİDASI 32   | M16 | 42 | 9  | 26 | 14 |
| 62040                        | TARAMA KİLİT VİDASI 40   | M20 | 52 | 10 | 30 | 17 |
| 62450                        | TARAMA KİLİT VİDASI 50   | M24 | 63 | 12 | 36 | 19 |
| 63060                        | TARAMA KİLİT VİDASI 60   | M30 | 75 | 14 | 45 | 22 |

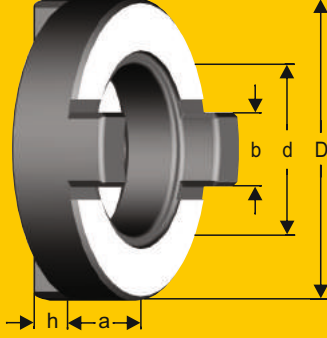

Sayfa : G-08  
Page : G-08



Sayfa : G-10  
Page : G-10



Sayfa : G-11  
Page : G-11

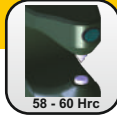

58 - 60 Hrc



| SİPARİŞ KODU<br>Order Number | ÜRÜN ADI<br>Product Name | d  | a  | D  | b  | h   |
|------------------------------|--------------------------|----|----|----|----|-----|
| 64016                        | K.T.B. 16 TIRNAKLI PUL   | 16 | 10 | 32 | 8  | 5   |
| 64022                        | K.T.B. 22 TIRNAKLI PUL   | 22 | 12 | 40 | 10 | 5,6 |
| 64027                        | K.T.B. 27 TIRNAKLI PUL   | 27 | 12 | 48 | 12 | 6,3 |
| 64032                        | K.T.B. 32 TIRNAKLI PUL   | 32 | 14 | 58 | 14 | 7   |
| 64040                        | K.T.B. 40 TIRNAKLI PUL   | 40 | 14 | 70 | 16 | 8   |



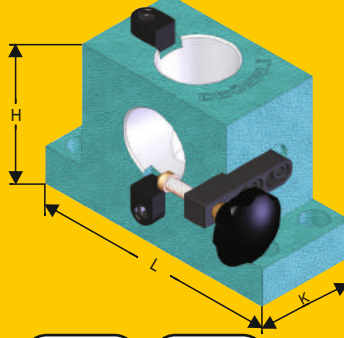

Bölüm : B  
Level : B



Bölüm : C  
Level : C



Bölüm : E  
Level : E



Sayfa : G-01  
Page : G-01



Sayfa : G-02  
Page : G-02



Sayfa : G-02  
Page : G-02

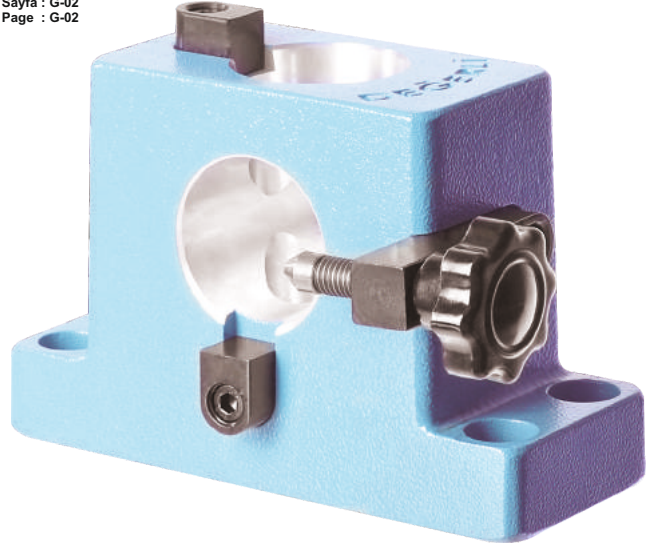

| SİPARİŞ KODU<br>Order Number | ÜRÜN ADI<br>Product Name                        | H   | L   | K  |
|------------------------------|---|-----|-----|----|
| 65030                        | ISO 30 / BT 30 / SK 30 ALÜMİNYUM MONTAJ APARATI | 75  | 127 | 47 |
| 65040                        | ISO 40 / BT 40 / SK 40 ALÜMİNYUM MONTAJ APARATI | 105 | 160 | 62 |
| 65050                        | ISO 50 / BT 50 / SK 50 ALÜMİNYUM MONTAJ APARATI | 155 | 180 | 99 |

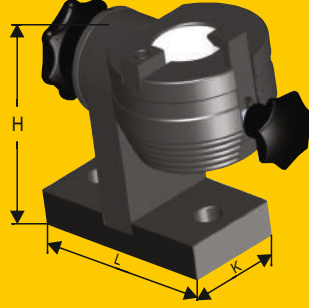

Bölüm : B  
Level : B



Bölüm : C  
Level : C



Bölüm : E  
Level : E



Sayfa : G-01  
Page : G-01



Sayfa : G-02  
Page : G-02



Sayfa : G-02  
Page : G-02

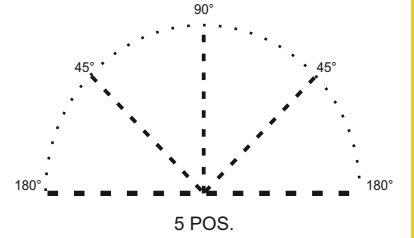

| SİPARİŞ KODU<br>Order Number | ÜRÜN ADI<br>Product Name                    | H   | L   | K  |
|------------------------------|---|-----|-----|----|
| 55030                        | ISO 30 / BT 30 / SK 30 ÇELİK MONTAJ APARATI | 121 | 100 | 48 |
| 55040                        | ISO 40 / BT 40 / SK 40 ÇELİK MONTAJ APARATI | 136 | 130 | 64 |
| 55050                        | ISO 50 / BT 50 / SK 50 ÇELİK MONTAJ APARATI | 170 | 170 | 72 |

# DIN 6388 D

## PENS KAPAĞI

Clamping nuts OZ DIN 6388 D  
ball-bearing version



# DEĞERLİ®

www.degerlimakina.com

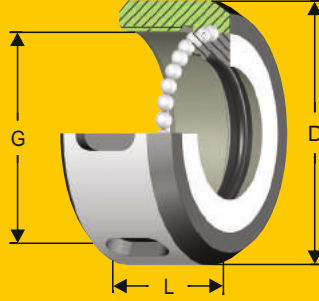

Sayfa / Page :  
A-06,07,08,09,10,11



Sayfa : G-01  
Page : G-01



Sayfa : G-10  
Page : G-10



Sayfa : G-11  
Page : G-11

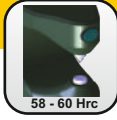

58 - 60 Hrc



| SİPARİŞ KODU<br>Order Number | ÜRÜN ADI<br>Product Name | KAPASİTE<br>Capacity | D  | G         | L    |
|------------------------------|--------------------------|----------------------|----|-----------|------|
| 40407                        | 407 KAPAK                | 2.....12 mm          | 35 | M27 x 1,5 | 20   |
| 40415                        | 415 KAPAK                | 2.....16 mm          | 43 | M33 x 1,5 | 24   |
| 40440                        | 440 KAPAK                | 2.....20 mm          | 50 | M42 x 2   | 28   |
| 40462                        | 462 KAPAK                | 2.....25 mm          | 60 | M48 x 2   | 30   |
| 40467                        | 467 KAPAK                | 3.....32 mm          | 72 | M60 x 2,5 | 33,5 |
| 40468                        | 468 KAPAK                | 3.....40 mm          | 85 | M68 x 2,5 | 37   |

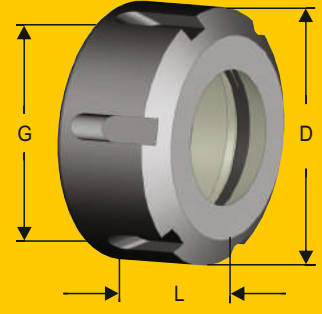
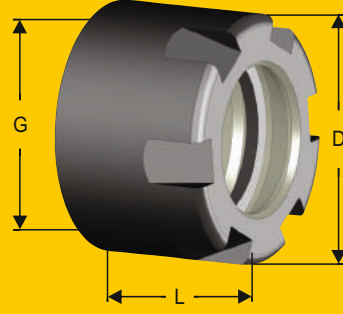
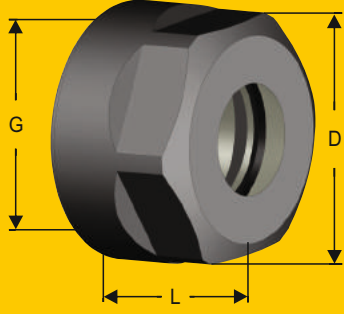

Sayfa / Page :  
A-01,02,03,04,05



Sayfa : G-02  
Page : G-02



Sayfa : G-02  
Page : G-02



Sayfa : G-10  
Page : G-10



Sayfa : G-11  
Page : G-11

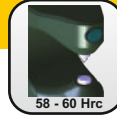

58 - 60 Hrc



| SİPARİŞ KODU<br>Order Number | ÜRÜN ADI<br>Product Name | KAPASİTE<br>Capacity | D  | G         | L    | SW |
|------------------------------|--------------------------|----------------------|----|-----------|------|----|
| 40426                        | ER 16 / 426 KAPAK        | 2.....10 mm          | 28 | M22 x 1,5 | 17,5 | 25 |
| 41426                        | ER 16 / 426 MİNİ KAPAK   | 2.....10 mm          | 22 | M19 x 1   | 18   | -- |
| 42426                        | ER 16 / 426 KAPAK        | 2.....10 mm          | 32 | M22 x 1,5 | 17,5 | -- |
| 40428                        | ER 20 / 428 KAPAK        | 2.....12 mm          | 34 | M25 x 1,5 | 19   | 30 |
| 41428                        | ER 20 / 428 MİNİ KAPAK   | 2.....12 mm          | 28 | M24 x 1   | 19   | -- |
| 40430                        | ER 25 / 430 KAPAK        | 2.....16 mm          | 42 | M32 x 1,5 | 20   | -- |
| 40470                        | ER 32 / 470 KAPAK        | 2.....20 mm          | 50 | M40 x 1,5 | 22,5 | -- |
| 40472                        | ER 40 / 472 KAPAK        | 2.....26 mm          | 63 | M50 x 1,5 | 25,5 | -- |

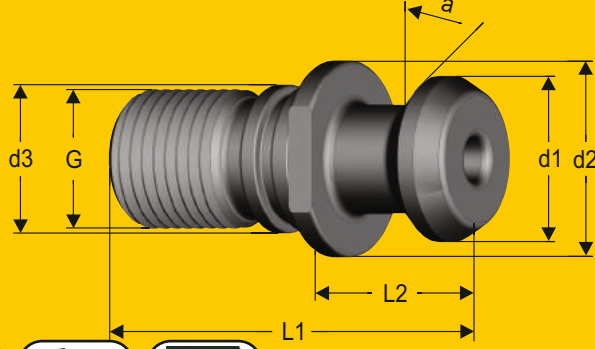

BÖLÜM : C  
Level : C



BÖLÜM : E  
Level : E



Sayfa : G-10  
Page : G-10



Sayfa : G-11  
Page : G-11

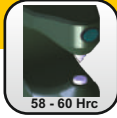

58 - 60 Hrc



| SİPARİŞ KODU<br>Order Number | ÜRÜN ADI<br>Product Name | d1    | d2   | d3 | L1    | L2    | G   | a   |
|------------------------------|--------------------------|-------|------|----|-------|-------|-----|-----|
| 21445                        | CAT 40 MAZAK PULLSTUD    | 18,80 | 22   | 17 | 41,25 | 16,10 | M16 | 45° |
| 21445.1                      | BT 40 MAZAK PULLSTUD     | 18,80 | 22,5 | 17 | 44,10 | 19,10 | M16 | 45° |
| 21545                        | ISO 7388 / B 50 PULLSTUD | 28,95 | 37   | 25 | 65,40 | 25,40 | M24 | 45° |
| 22445                        | ISO 7388 / B 40 PULLSTUD | 18,95 | 22,5 | 17 | 44,50 | 16,40 | M16 | 45° |
| 22545                        | CAT 50 MAZAK PULLSTUD    | 29,10 | 37   | 25 | 65,50 | 25,55 | M24 | 45° |



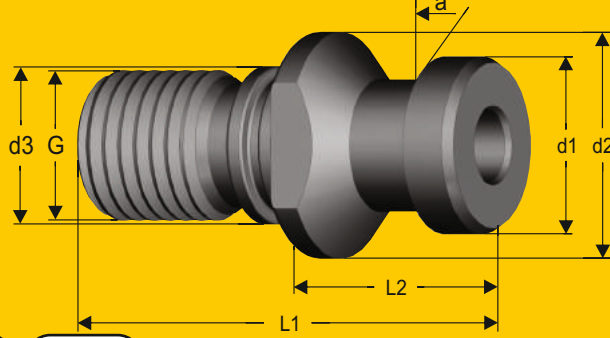

BÖLÜM : E  
Level : E



Sayfa : G-10  
Page : G-10



Sayfa : G-11  
Page : G-11

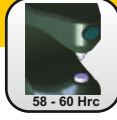

58 - 60 Hrc



| SİPARİŞ KODU<br>Order Number | ÜRÜN ADI<br>Product Name        | d1 | d2 | d3 | L1 | L2 | G   | a   |
|------------------------------|---------------------------------|----|----|----|----|----|-----|-----|
| 23015                        | DIN 69872 SK 30 PULLSTUD        | 13 | 17 | 13 | 44 | 24 | M12 | 15° |
| 24015                        | DIN 69872 SK 40 PULLSTUD        | 19 | 23 | 17 | 54 | 26 | M16 | 15° |
| 25015                        | DIN 69872 SK 50 PULLSTUD        | 28 | 36 | 25 | 74 | 34 | M24 | 15° |
| 24115                        | DIN 69872 SK 40 İ.S.V. PULLSTUD | 19 | 23 | 17 | 54 | 26 | M16 | 15° |
| 25115                        | DIN 69872 SK 50 İ.S.V. PULLSTUD | 28 | 36 | 25 | 74 | 34 | M24 | 15° |

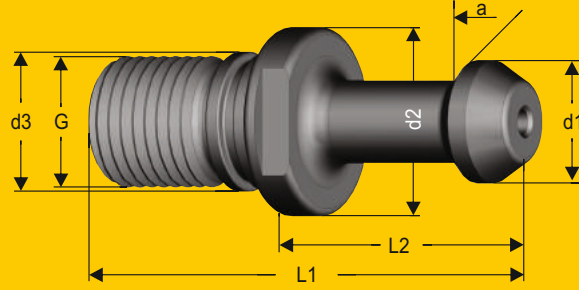

BÖLÜM : C  
Level : C



Sayfa : G-10  
Page : G-10



Sayfa : G-11  
Page : G-11

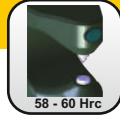

58 - 60 Hrc



| SİPARİŞ KODU<br>Order Number | ÜRÜN ADI<br>Product Name | d1 | d2   | d3   | L1 | L2 | G   | a   |
|------------------------------|--------------------------|----|------|------|----|----|-----|-----|
| 23045                        | MAS 403 BT 30 PULLSTUD   | 11 | 16,5 | 12,5 | 43 | 23 | M12 | 45° |
| 24045                        | MAS 403 BT 40 PULLSTUD   | 15 | 23   | 17   | 60 | 35 | M16 | 45° |
| 25045                        | MAS 403 BT 50 PULLSTUD   | 23 | 38   | 25   | 85 | 45 | M24 | 45° |
| 23060                        | MAS 403 BT 30 PULLSTUD   | 11 | 16,5 | 12,5 | 43 | 23 | M12 | 60° |
| 24060                        | MAS 403 BT 40 PULLSTUD   | 15 | 23   | 17   | 60 | 35 | M16 | 60° |
| 25060                        | MAS 403 BT 50 PULLSTUD   | 23 | 38   | 25   | 85 | 45 | M24 | 60° |
| 23090                        | MAS 403 BT 30 PULLSTUD   | 11 | 16,5 | 12,5 | 43 | 23 | M12 | 90° |
| 24090                        | MAS 403 BT 40 PULLSTUD   | 15 | 23   | 17   | 60 | 35 | M16 | 90° |
| 25090                        | MAS 403 BT 50 PULLSTUD   | 23 | 38   | 25   | 85 | 45 | M24 | 90° |

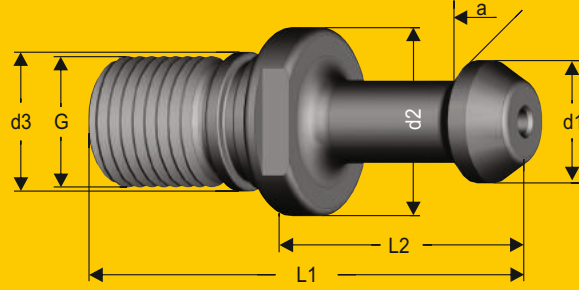

BÖLÜM : C  
Level : C



Sayfa : G-10  
Page : G-10



Sayfa : G-11  
Page : G-11

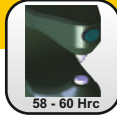

58 - 60 Hrc



| SİPARİŞ KODU<br>Order Number | ÜRÜN ADI<br>Product Name      | d1 | d2 | d3 | L1 | L2 | G   | a   |
|------------------------------|-------------------------------|----|----|----|----|----|-----|-----|
| 24145                        | MAS 403 BT 40 İ.S.V. PULLSTUD | 15 | 23 | 17 | 60 | 35 | M16 | 45° |
| 25145                        | MAS 403 BT 50 İ.S.V. PULLSTUD | 23 | 38 | 25 | 85 | 45 | M24 | 45° |
| 24160                        | MAS 403 BT 40 İ.S.V. PULLSTUD | 15 | 23 | 17 | 60 | 35 | M16 | 60° |
| 25160                        | MAS 403 BT 50 İ.S.V. PULLSTUD | 23 | 38 | 25 | 85 | 45 | M24 | 60° |
| 24190                        | MAS 403 BT 40 İ.S.V. PULLSTUD | 15 | 23 | 17 | 60 | 35 | M16 | 90° |
| 25190                        | MAS 403 BT 50 İ.S.V. PULLSTUD | 23 | 38 | 25 | 85 | 45 | M24 | 90° |

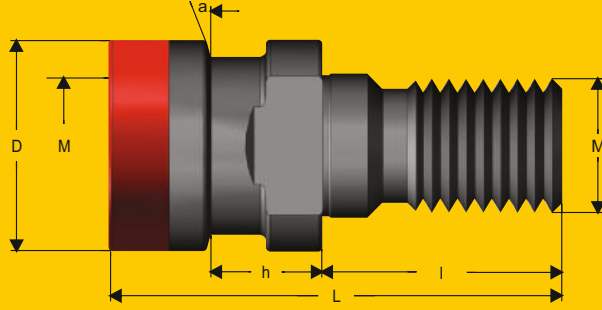

BÖLÜM : C  
Level : C



Sayfa : G-10  
Page : G-10



Sayfa : G-11  
Page : G-11

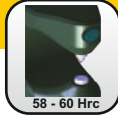

58 - 60 Hrc



| SİPARİŞ KODU<br>Order Number | ÜRÜN ADI<br>Product Name     | D    | M   | L  | I  | h    | a   |
|------------------------------|------------------------------|------|-----|----|----|------|-----|
| 26016                        | 40 İÇTEN ÇEKTİRMELİ PULLSTUD | 25   | M16 | 53 | 28 | 13,7 | 15° |
| 26024                        | 50 İÇTEN ÇEKTİRMELİ PULLSTUD | 39,2 | M24 | 65 | 40 | 13   | 15° |

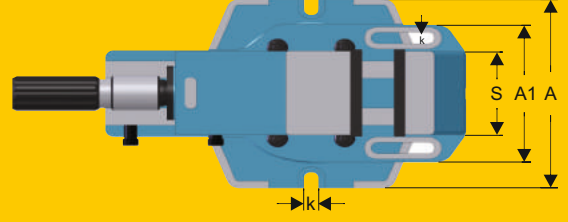
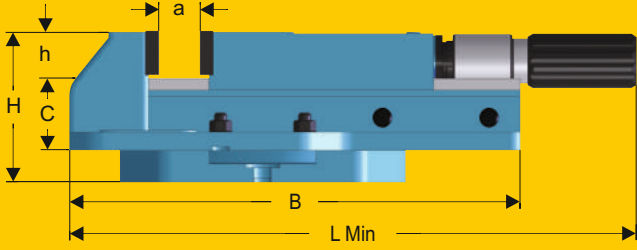

| SİPARİŞ KODU<br>Order Number | ÜRÜN ADI<br>Product Name | A   | A1  | S   | k  | a     | h  | H   | C  | B   | L<br>MIN |
|------------------------------|--------------------------|-----|-----|-----|----|-------|----|-----|----|-----|----------|
| 10100                        | HİDROLİK MENGENE         | 270 | 200 | 122 | 16 | 0-210 | 45 | 140 | 68 | 425 | 500      |

| SIKMA GÜCÜ<br>Press Power | AĞIRLIK<br>Weight |
|---------------------------|-------------------|
| 3,5 - 4 TON               | 35 KG             |



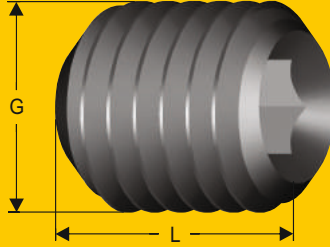

Sayfa : B-06,07  
Page : B-06,07



Sayfa / Page :  
C-13,14,15,16,17,18



Sayfa / Page :  
E-12,13,14,15,16,17



Sayfa : G-10  
Page : G-10



Sayfa : G-11  
Page : G-11



| SİPARİŞ KODU<br>Order Number | ÜRÜN ADI<br>Product Name | G       | L  |
|------------------------------|--------------------------|---------|----|
| 9006                         | WELDON 6                 | M6      | 10 |
| 9008                         | WELDON 8                 | M8      | 10 |
| 9010                         | WELDON 10                | M10     | 12 |
| 9012                         | WELDON 12                | M12     | 16 |
| 9016                         | WELDON 16                | M14     | 16 |
| 9020                         | WELDON 20                | M16     | 16 |
| 9025                         | WELDON 25                | M18 x 2 | 20 |
| 9032                         | WELDON 32                | M20 x 2 | 20 |
| 9040                         | WELDON 40                | M20 x 2 | 20 |

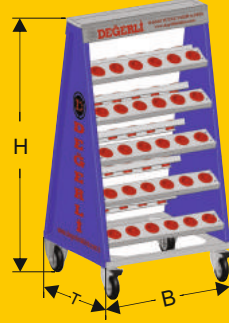
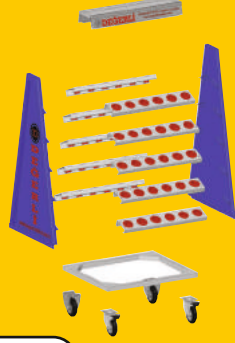

BÖLÜM : B  
Level : B



BÖLÜM : C  
Level : C



BÖLÜM : E  
Level : E



| SİPARİŞ KODU<br>Order Number | ÜRÜN ADI<br>Product Name             | KAPASİTE<br>Capacity | H    | T   | B   |
|------------------------------|--------------------------------------|----------------------|------|-----|-----|
| 8030                         | ISO 30 / BT 30 / SK 30 TAKIM ARABASI | 70                   | 1260 | 600 | 700 |
| 8040                         | ISO 40 / BT 40 / SK 40 TAKIM ARABASI | 60                   | 1260 | 600 | 700 |
| 8050                         | ISO 50 / BT 50 / SK 50 TAKIM ARABASI | 50                   | 1260 | 600 | 700 |